



# evo<sup>®</sup>

## Operator's Manual

Indoor Use Only

Event<sup>®</sup> 48E FMS Display Cooking Station

Ductless Downdraft Ventilation  
Cooking Equipment



# **WARNING**

**YOUR EVO EVENT COOKING UNIT IS EQUIPPED WITH AN AUTOMATIC & MANUAL ACTUATED FIRE SUPPRESSION SYSTEM.**

**FAILURE TO COMMISSION AND ACTIVATE THE FIRE SUPPRESSION SYSTEM BY AN "AUTHORIZED BUCKEYE FIRE EQUIPMENT DEALER" MAY RESULT IN SYSTEM FAILURE, INJURY, OR DEATH.**

|  |       |   |       |
|--|-------|---|-------|
| <b>SAFETY WARNINGS</b>                                 | 4     |   |       |
| <b>LIMITED WARRANTY</b>                                | 5-6   |   |       |
| <b>INTRODUCTION</b>                                    |       |   |       |
| What is Live-Action Display Cooking                    | 7     |   |       |
| Handling Grease and Smoke Laden Air                    | 7     |   |       |
| Unique Innovation                                      | 7     |   |       |
| About Evo America, LLC                                 | 7     |   |       |
| The Evo EVent® FMS Display Cooking Station             | 8     |   |       |
| <b>EQUIPMENT FEATURES</b>                              |       |   |       |
| Know Your EVent® 48E Cooking Station                   | 9     |   |       |
| <b>CONTROL PANEL</b>                                   |       |   |       |
| Status Screen  | 10    |   |       |
| Startup Screen Warning                                 | 11    |   |       |
| Startup Screen   | 12    |   |       |
| Ventilation Startup                                    | 13    |   |       |
| Ventilation Startup - FAULT                            | 14    |   |       |
| Ventilation Startup - FAULT Service Instruction        | 15    |   |       |
| Cooktop Startup  | 16    |   |       |
| Administration Settings - Overview                     | 17    |   |       |
| Administration Settings - Select Temperature Presets   | 18-19 |   |       |
| User Settings - Use Manual Temperature                 | 20    |   |       |
| Factory Settings - Overview                            | 21    |   |       |
| Factory Settings - Actual Temperature                  | 22    |   |       |
| Factory Settings - Set Temperature Offsets             | 23    |   |       |
| <b>MAINTENANCE</b>                                     |       |   |       |
| Cleaning - Stainless Steel Panels                      | 24    |   |       |
| Cleaning - Granite Cooktop Surfaces                    | 25    |   |       |
| Cleaning - The Griddle Surface                         | 26    |   |       |
| Cleaning - Ventilation Inlet Aperture                  | 27    |   |       |
| Cleaning - Ventilation Inlet Duct                      | 28    |   |       |
| Cleaning - The Crumb Drawer                            | 29    |   |       |
| Cleaning - The Grease Filter                           | 30    |   |       |
| Cleaning - The Grease Filter Enclosure Part 1          | 31    |   |       |
| Cleaning - The Grease Filter Enclosure Part 2          | 32    |   |       |
| Cleaning - The Electrostatic Precipitator (ESP) Part 1 | 33    |   |       |
| Cleaning - The Electrostatic Precipitator (ESP) Part 2 | 34    |   |       |
| Cleaning - The Electrostatic Precipitator Pre-Filter   | 35    |   |       |
| Cleaning - The Electrostatic Precipitator Bottom Pan   | 36    |   |       |
| Replacing - The Disposable Charcoal Post Filter        | 37    |   |       |
|  |       | <b>TROUBLESHOOTING ISSUES</b>                             |       |
|  |       | On/Off Button Will Not Respond                            | 38    |
|  |       | The Fan Starts Then Stops After 5-10 Seconds              | 38    |
|  |       | The Fan Starts Then Stops When Cooking                    | 38    |
|  |       | The Display Appears Functional But The Fan Does Not Start | 38    |
|  |       | The Display Is Grey or The Display Does Not Respond       | 39    |
|  |       | The Upper Left Side Heater Is Over Heating                | 39    |
|  |       | The COOK Button Is ON But The Heaters Are Not Heating     | 39    |
|  |       | The Display Shows Red Fault Indicators                    | 39    |
|  |       | <b>CONTROL PANEL DISPLAY - FAULT INDICATORS</b>           |       |
|  |       | FAULT #1 - Aperture Inlet Duct                            | 40    |
|  |       | FAULT #2 - Crumb Drawer                                   | 40    |
|  |       | FAULT #3 - Grease Filter                                  | 40    |
|  |       | FAULT #4 - Grease Drawer                                  | 40    |
|  |       | FAULT #5 - Pre-Filter                                     | 40    |
|  |       | FAULT #6 - Charcoal Filter                                | 40    |
|  |       | <b>APPENDIX 1-7</b>                                       |       |
|  |       | #1 REQUIRED EVENT SYSTEM MAINTENANCE SCHEDULE             | 41-42 |
|  |       | #2 FILTER AND SURFACE CLEANING MAINTENANCE SCHEDULE       | 43    |
|  |       | #3 CLEANING THE COOKING SURFACE                           | 44    |
|  |       | #4 FIRE SUPPRESSION SYSTEM                                | 45-47 |
|  |       | #5 RESTARTING AFTER A FIRE SYSTEM DISCHARGE               | 48    |
|  |       | #6 FIRE SYSTEM ALARM MICRO SWITCH                         | 49    |
|  |       | #7 SPECIFICATIONS   | 50    |

**Repair Service Provided By Evo America, LLC**

**Please call 866-626-1802  
Monday - Friday 8am-6pm pst**

**FOR YOUR SAFETY - Storing Flammable Materials**

DO NOT STORE OR USE GASOLINE OR OTHER FLAMMABLE VAPORS OR LIQUIDS IN THE VICINITY OF THIS OR ANY OTHER APPLIANCE.

**WARNING - Do Not Misuse Equipment**

IMPROPER INSTALLATION, ADJUSTMENT, ALTERATION, SERVICE OR MAINTENANCE CAN CAUSE PROPERTY DAMAGE, INJURY, OR DEATH. READ THE INSTALLATION, OPERATING AND MAINTENANCE INSTRUCTIONS THOROUGHLY BEFORE POSITIONING, INSTALLING, MAINTAINING OR SERVICING THIS EQUIPMENT.

**PLEASE READ ALL SECTIONS OF THIS MANUAL AND RETAIN FOR FUTURE REFERENCE.**

**THE UNIT WHEN INSTALLED, MUST BE ELECTRICALLY GROUNDED AND COMPLY WITH LOCAL CODES, OR IN THE ABSENCE OF LOCAL CODES, WITH THE NATIONAL ELECTRICAL CODE.**

Users are cautioned that maintenance and repairs must be performed by an Evo America, LLC Authorized Service Agent using genuine Evo America, LLC Replacement parts. Evo America, LLC will have no obligation with respect to any product that has been improperly installed, adjusted, operated or maintained in accordance with national and local codes or installation instructions provided with the product, or any product that has its serial number defaced, obliterated or removed, or which has been modified or repaired using unauthorized parts or by unauthorized service agents. The information contained herein, (including design and parts specifications), may be superseded and is subject to change without notice.

- This unit must be operated by a qualified person.
- **DO NOT** operate without reading this manual.
- **DO NOT** attempt to repair or replace any part of this appliance unless all main power supplies have been disconnected.
- **DO NOT** clean this appliance unless the power supply is disconnected.
- **USE EXTREME CAUTION** in setting up, operating and cleaning this appliance to avoid coming in contact with hot surfaces (including parts). Wear suitable protective clothing or use proper utensils to prevent the risk of burns.

**IMMEDIATELY INSPECT FOR SHIPPING DAMAGE**

All containers must be examined for damage before and during unloading. The freight carrier has assumed responsibility for its safe transit and delivery. If equipment is received damaged, either apparent or concealed, a claim must be made with the delivering freight carrier.

## Commercial Limited Warranty for the EVent® Units

Evo Inc. warrants to the original commercial foodservice purchaser that the Evo EVent® Cooktop with Downdraft Ventilation will be free from defects in material and workmanship for a period of one (1) year from the original installation date, or 90 days after shipment, whichever is earlier. Evo's obligation under this warranty shall be limited to replacing or repairing, at its option, any part found to be defective within the specified warranty period. Any labor expense or part failure incurred after the warranty period will be the responsibility of the end user.

This warranty is non-transferable and applies only to the original purchaser/owner to whom the Evo EVent® Cooktop was delivered. Any such transfer shall void the warranty.

The end-user purchasing an Evo product to which this warranty applies is urged to register their product online at <http://www.evoamerica.com/event-care/>. Upon registration, the warranty period will commence as provided above.

**The EVent® includes four (4) filters that must be monitored and cleaned regularly to prevent grease infiltration that will impede the efficient operation of the unit and may cause damage to components. Cleaning and maintenance instructions are included in the EVent® Operators Manual and Evo provided training material. Service calls and/or part replacement resulting from lack of maintenance may not be covered under this warranty.**

### **THIS WARRANTY DOES NOT COVER**

1. Damage, part failure or performance issues resulting from lack of regular filter cleaning and maintenance as detailed in the EVent® Operators Manual, and Evo provided training material. Cost of repair calls scheduled by Evo during the warranty period and found to be resulting from lack of filter maintenance will be charged to the end user.
2. Any defect or cosmetic damage to cooktop or stainless-steel cabinetry due to or resulting from ordinary wear and tear, handling, abuse, misuse or during installation.
3. Any damage resulting from voltage conditions, blown fuses, open circuit breakers or any other damage due to the inadequacy or interruption of electrical service.
4. Any unit from which the serial number has been removed or altered, or modifications made by unauthorized service personnel.
5. Damages as a result of floods, winds, fires, lightning, accidents, corrosive environment, improper installation or installation not in accordance with local electrical codes.

**IMPORTANT: THE DISCHARGE OF THE FIRE SUPPRESSION SYSTEM IS LIKELY TO DAMAGE THE EVent® UNIT. THE WARRANTY IS NO LONGER VALID AFTER THE FIRE SUPPRESSION SYSTEM IS DISCHARGED. NOTIFY EVO IF THE FIRE SYSTEM IS DISCHARGED FOR PROPER CLEANUP PROCEDURE AND/OR REPAIR SCHEDULING.**

Evo, or its suppliers, shall not be liable, directly or indirectly, under any circumstances for consequential or incidental damages, including, but not limited to: (i) any loss of business or profits; and (ii) labor, material or other charges, claims losses or damages incurred or suffered from, in connection with or in consequence of the working upon, alteration, or repair of any such defective products or parts by persons or firms other than contracted directly by Evo.

## WHEN WARRANTY REPAIR IS NEEDED

### How To Contact Evo

1. Call Evo directly at 503-626-1802
2. Email [support@evoamerica.com](mailto:support@evoamerica.com)
3. Complete online Evo Service Request Form at <http://www.evoamerica.com/event-care/>

### Information Needed

1. Provide the EVent® model and serial number
2. Provide as much detail as possible on the problem – what happened, when did the problem start
3. Provide any relevant pictures of damage or condition of unit
4. Provide phone numbers and email for site contact
5. Provide details on any special access or service company requirements that could prevent completion of a service call

*Evo will contact the site to obtain details and ask diagnostic questions, and Evo will schedule an authorized warranty service provider. If determined necessary, Evo will send the required parts directly to the customer location to hold for a technician.*

## What is Live-Action Display Cooking

Live-Action Display Cooking is performed by a chef in front of an audience where the chef creates theater and participation by engaging people with the sights, sounds and flavors of freshly prepared food. Every culture cooks foods in an open kitchen or outdoors where food preparation is equal parts flavor and entertainment, and the cooking equipment is as varied as our culture such as American barbecue, French rotisserie and Brazilian churrasco, to Chinese wok and Japanese teppan cooking.

## Handling Grease and Smoke Laden Air

Of the thousands of variations of display cooking equipment a chef can employ, one of the most versatile cooking platforms is the heated flat plancha or teppan griddle plate. Unfortunately when used indoors, this style of griddle plate inevitably produces grease laden air which is an undesirable byproduct that can be a health hazard to both the chef and the audience. The conventional way of dealing with this issue is to install ventilation devices such as a grease hood above the griddle. This hood is connected to an air/grease duct that leads to the outside, providing the air passage through which grease laden air can be removed by a suction motor (often installed at the end of the air duct).

## Unique Innovation

The Evo EVent® Ductless Downdraft Ventilation Cooktop is an innovative design that includes a high-efficiency griddle integrated to a ventilation system that extracts air across the griddle surface through a series of filters including an electrostatic precipitator that removes smoke and grease particulates before exhausting clean air.

This high-efficiency griddle and ventilation system is individually patented technologies which benefit operators, chefs, and restaurant patrons by reducing the risk of worker related respiratory illness and contributes to better air quality of the restaurant.

## About Evo America, LLC

Evo was founded by innovative food people with a passion for cooking and entertaining. As a cooking equipment manufacturer, it's our love of connecting people around food that guides everything we do. Since 2001, we have built a full line of exceptionally energy-efficient gas and electric, indoor and outdoor, commercial and residential, flattop cooking equipment, all designed to create a social cooking experience. Made in America, Evo equipment is the leading live-action display cooking equipment in the world and built to last a lifetime. Our commercial cooktops are used by foodservice professionals and top chefs as a versatile cooking platform, and as a conduit to communicate a fresh-prepared, farmer-to-table message. Evo commercial equipment can be found at Whole Foods, Google, Apple, Microsoft, Marriott, Sheraton, Hyatt, Hilton, and hundreds of other A-list companies. Our residential cooking appliances compliment indoor and outdoor kitchens, and are used by thousands of consumers as a fun, healthy, and social way to cook for family and friends.

## The Evo EVent® 48E FMS Display Cooking Station

The team at Evo America, LLC and our engineering partners collaborated with teppanyaki master chefs to create the world's most advanced ductless downdraft ventilation teppanyaki cooking table.

Conceived and designed from the ground up, the Evo EVent® FMS Display Cooking Station is designed to be operated without an overhead or ducted ventilation hood, or a secondary fire suppression system. The EVent® is fully self contained, with a UL certified integral grease and smoke capture system and a UL certified internal fire suppression system.

Easy to use and maintain, the EVent® operates on 208V - 220V electrical supply that runs the heating elements and the ductless downdraft ventilation system. The high efficiency 4-zone heating elements are electronically controlled with user adjustable temperature presets and a conservation cycle that only applies power to the cooking surface when needed.

The ventilation system is constructed of fully welded stainless steel and utilizes washable primary grease filters, a washable electrostatic precipitator filter cartridge, and a replaceable activated charcoal post-filter. For convenience, all duct and filter cleaning happens from the chefs-side of the table.

The EVent® is portable and designed to be wheeled into a restaurant and easily repositioned. If table arrangements within the restaurant change you can simply move and relocate the table to a new position. If a restaurant location changes, the EVent® can be moved to a new location and quickly setup for operation.

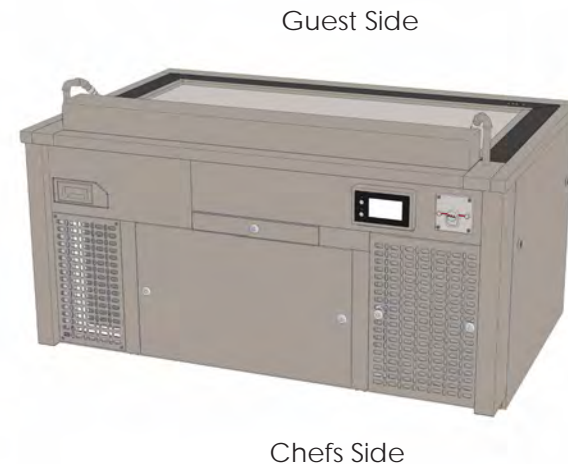

Guest Side

Chefs Side



### Know Your Event® 48E FMS Display Cooking Station

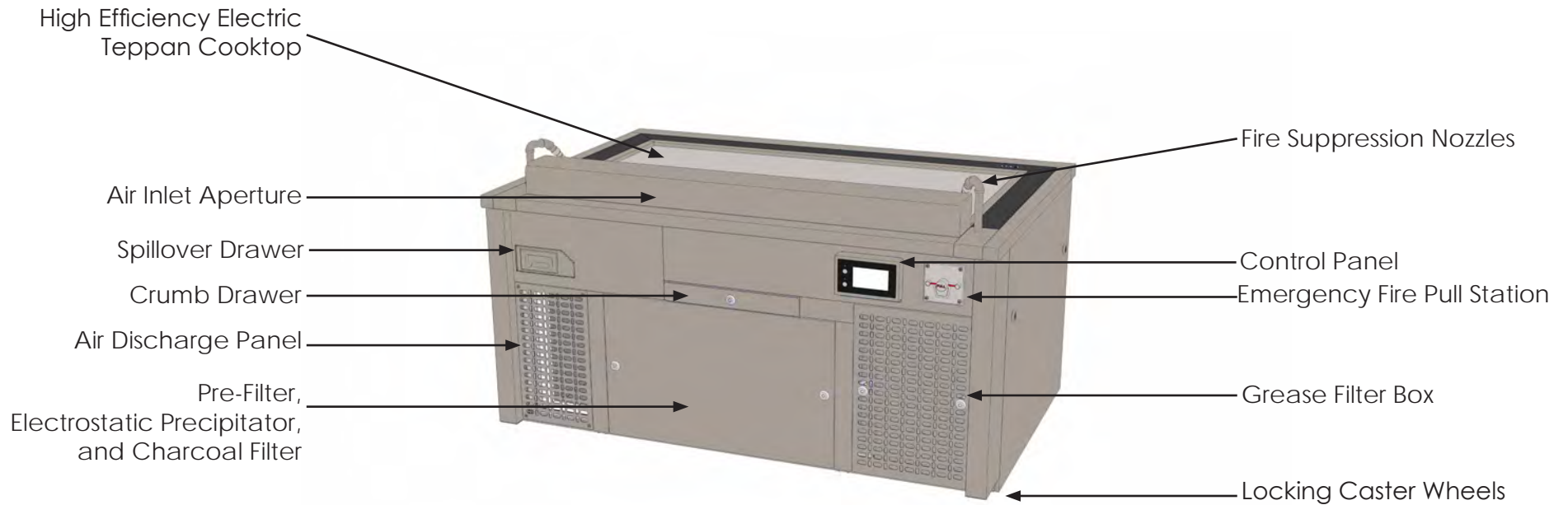

Status Screen

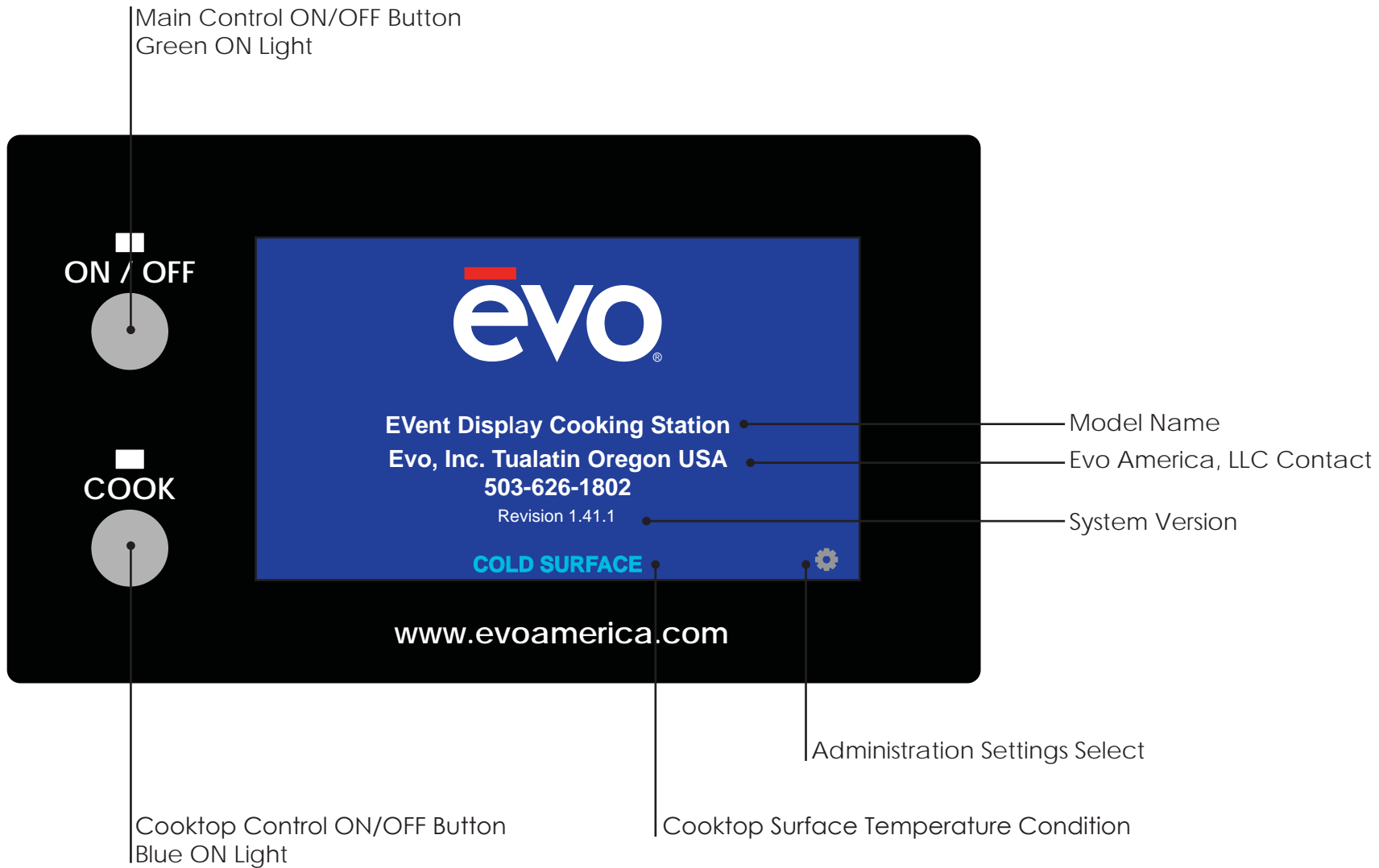

Startup Screen - Warning

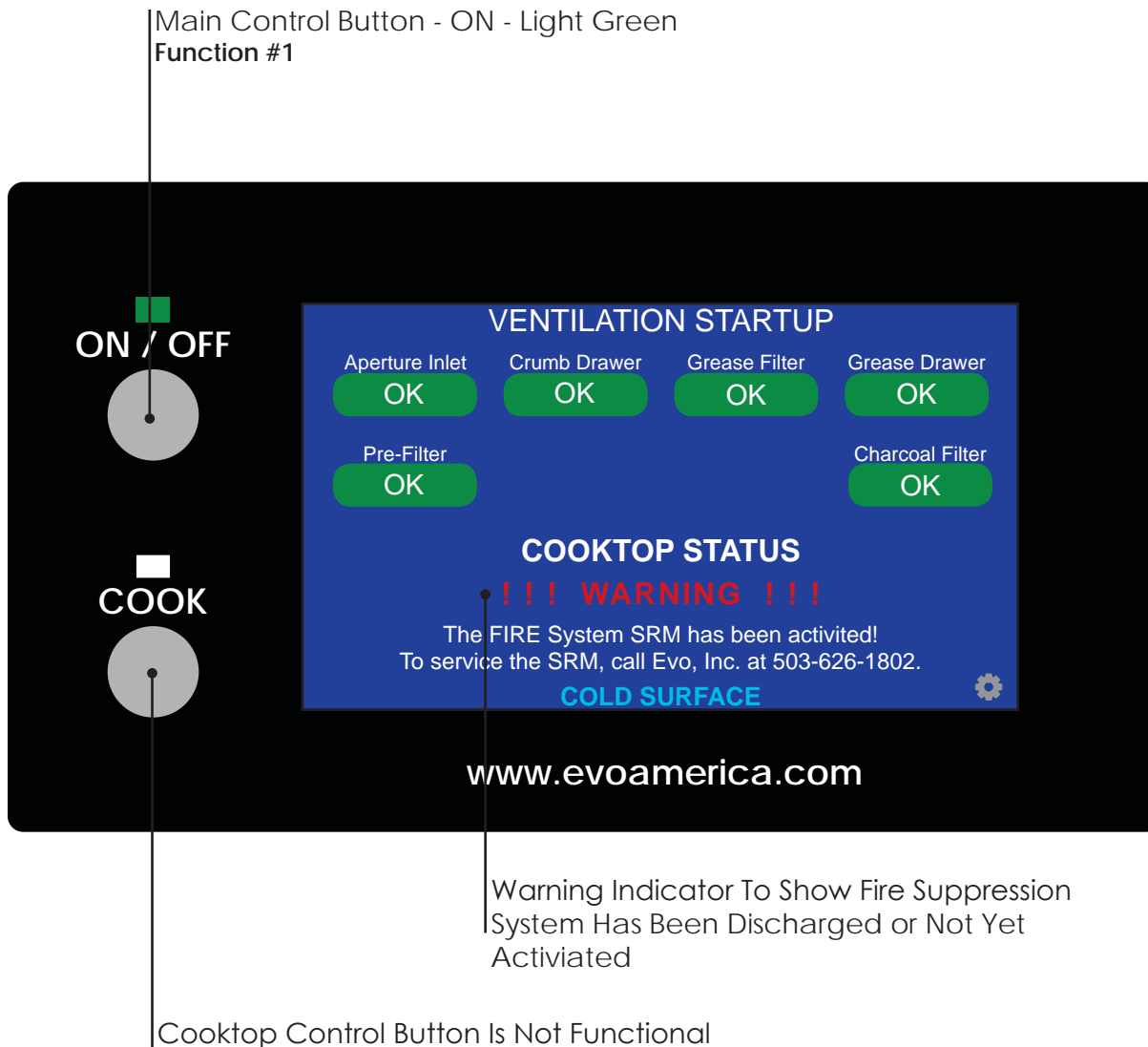

WHAT TO DO IF YOU SEE A STARTUP WARNING SCREEN

If the ON button is depressed and the Ventilation Startup screen shows WARNING, this indicates the unit has experienced a fire suppression system discharge or has not been 'fire commissioned' to setup and arm the fire suppression system.

If the fire suppression system has been discharged, the COOK button becomes inactive until the system is serviced by an authorized fire suppression system contractor.

If you witness fire suppression chemical on the cooking surface and throughout the internal duct system, immediately wash the internal duct system and all metal filters and dispose of the charcoal filter. Thoroughly clean all surfaces with soap and water. Call your authorized fire suppression system contractor to have the unit serviced.

If the Event unit is newly installed, the fire suppression system may not be 'fire commissioned' to arm and activate the fire suppression system. If the system is not activated, the COOK button will be inactive and no temperature will be available on the cooking surface.

Startup Screen

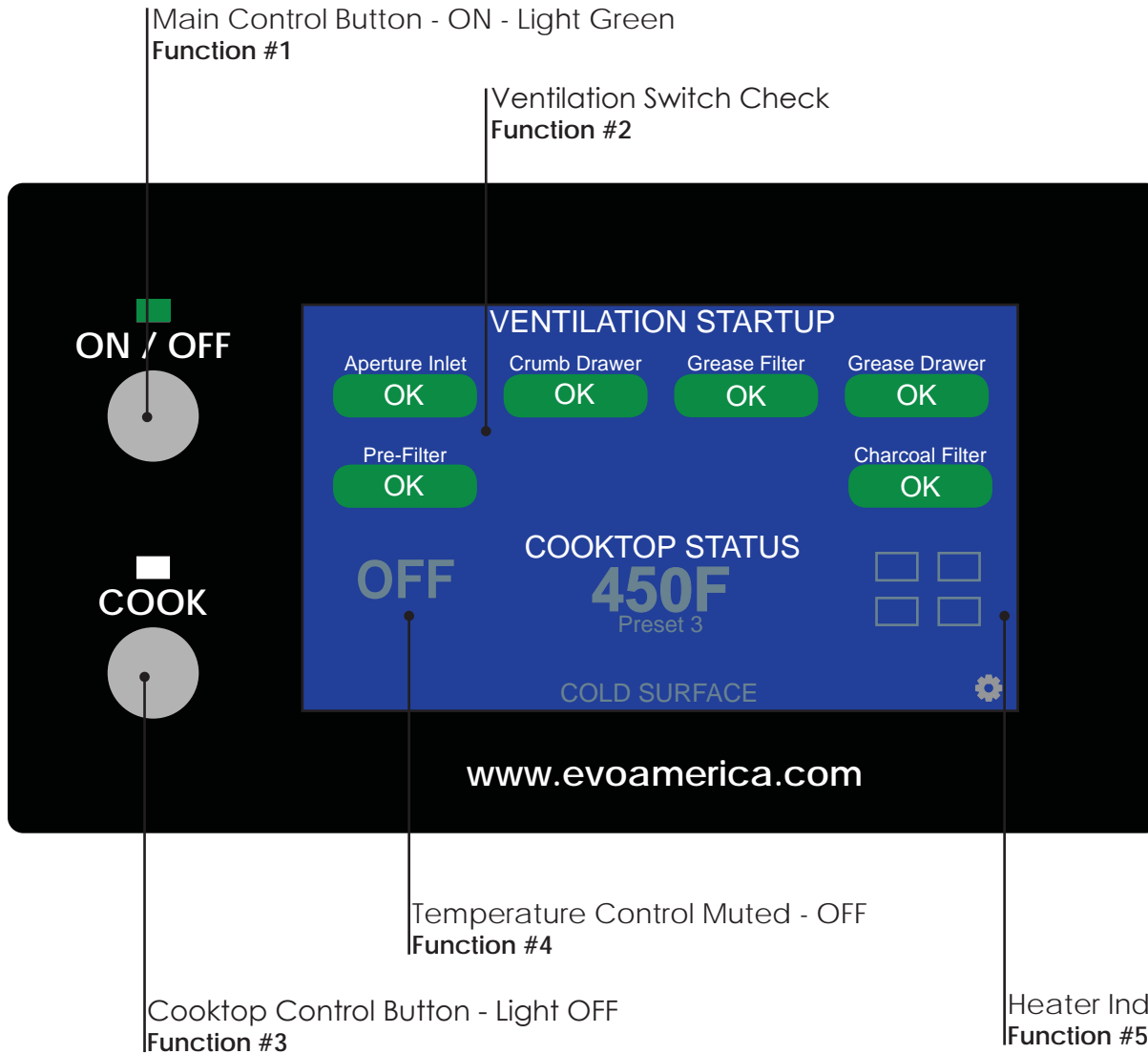

FUNCTIONS

- #1 When the ON button is pressed, the light shows green to indicate unit is ON. The Event unit performs a Ventilation System Check and confirms the unit is ready for operation
- #2 The Ventilation System Check confirms all critical ventilation components are functioning correct - OK.
- #3 Cooktop is disabled until ventilation component check confirms all critical ventilation components are functioning correct - OK.
- #4 Cooktop temperature control is disabled with muted color until COOK button is pressed and COOK light shows blue.
- #5 Heater indicator is disabled with muted color until COOK button is pressed and COOK light shows blue.

### Ventilation Startup

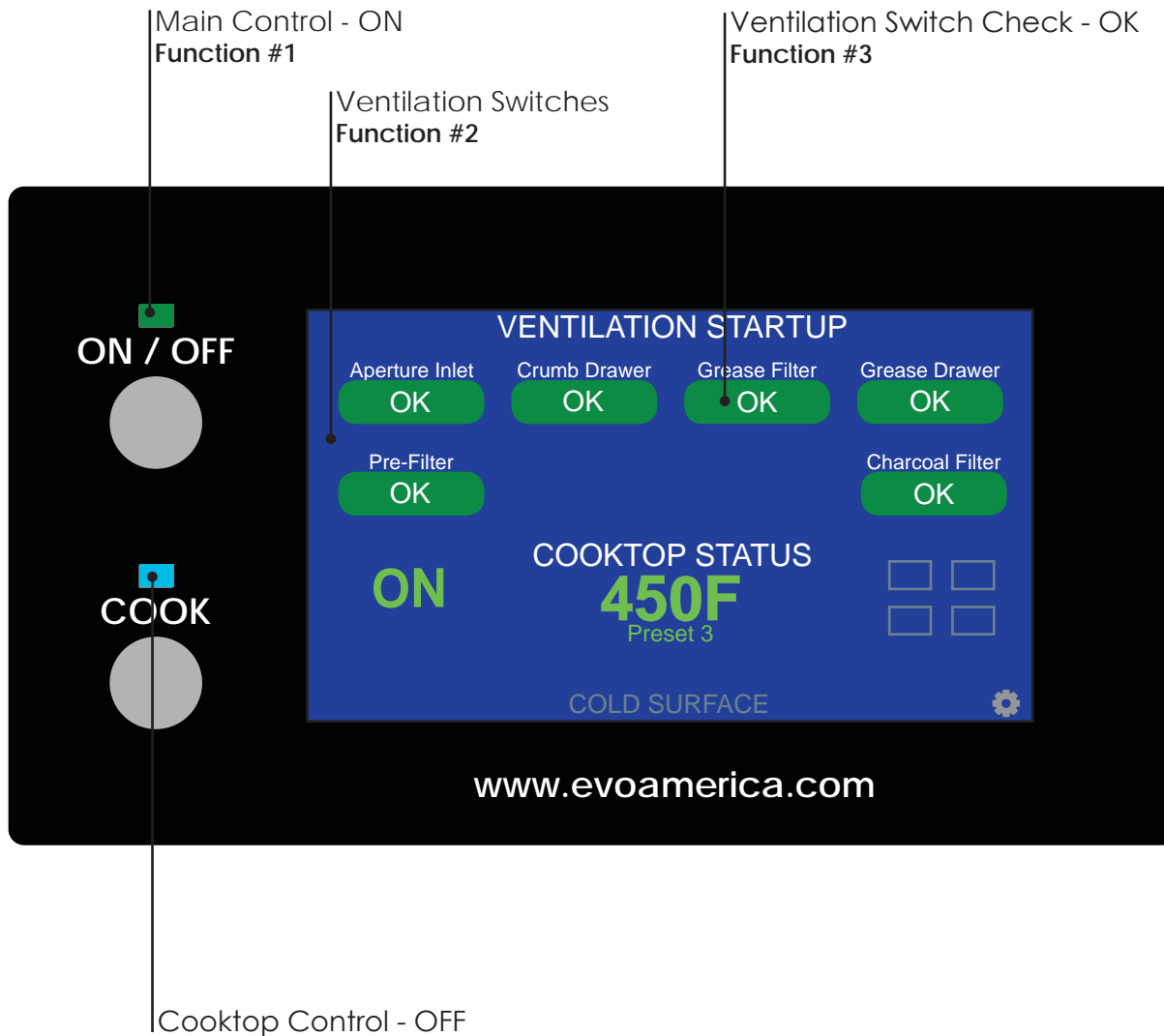

#### FUNCTION

- #1 For Ventilation System Startup, select Main Control to the ON position.
- #2 The ventilation system will startup and check 6 ventilation components.
- #3 Each ventilation component will indicate OK in green when the ventilation system is functioning correct.

#### NOTE:

There are 6 ventilation component checks performed before the EVent system will power ON.

Each ventilation component relates to an electrical switch that determines if a component is functioning correct.

The following is a list of Ventilation Startup Switch Components:

- 1 - Aperture Inlet
- 2 - Crumb Drawer
- 3 - Grease Filter
- 4 - Grease Drawer
- 5 - Pre-Filter
- 6 - Charcoal Filter

Ventilation Startup - FAULT

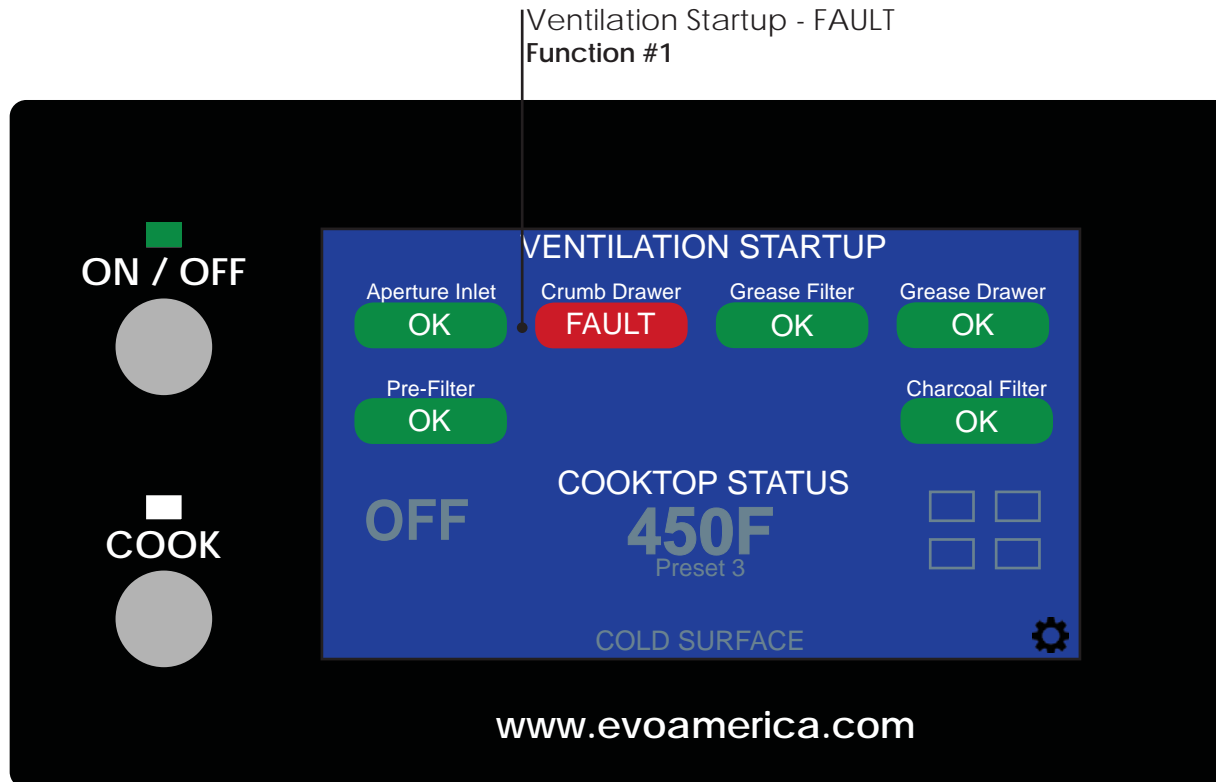

FUNCTION

#1 If a ventilation switch component is not functioning correctly, a red FAULT warning is shown next to the switch component name.

To view corrective information about the fault, press the FAULT button to view the related Service Instruction.

NOTE:

During EVent unit operation, if any ventilation startup switch component is not functioning correctly, a fault will occur and the ventilation fan will automatically shut down.

To restart the system, once the fault is cleared, cycle the power OFF/ON.

For a list of ventilation faults and related service instructions, refer to Page 40.

## Ventilation Startup - FAULT Service Instruction

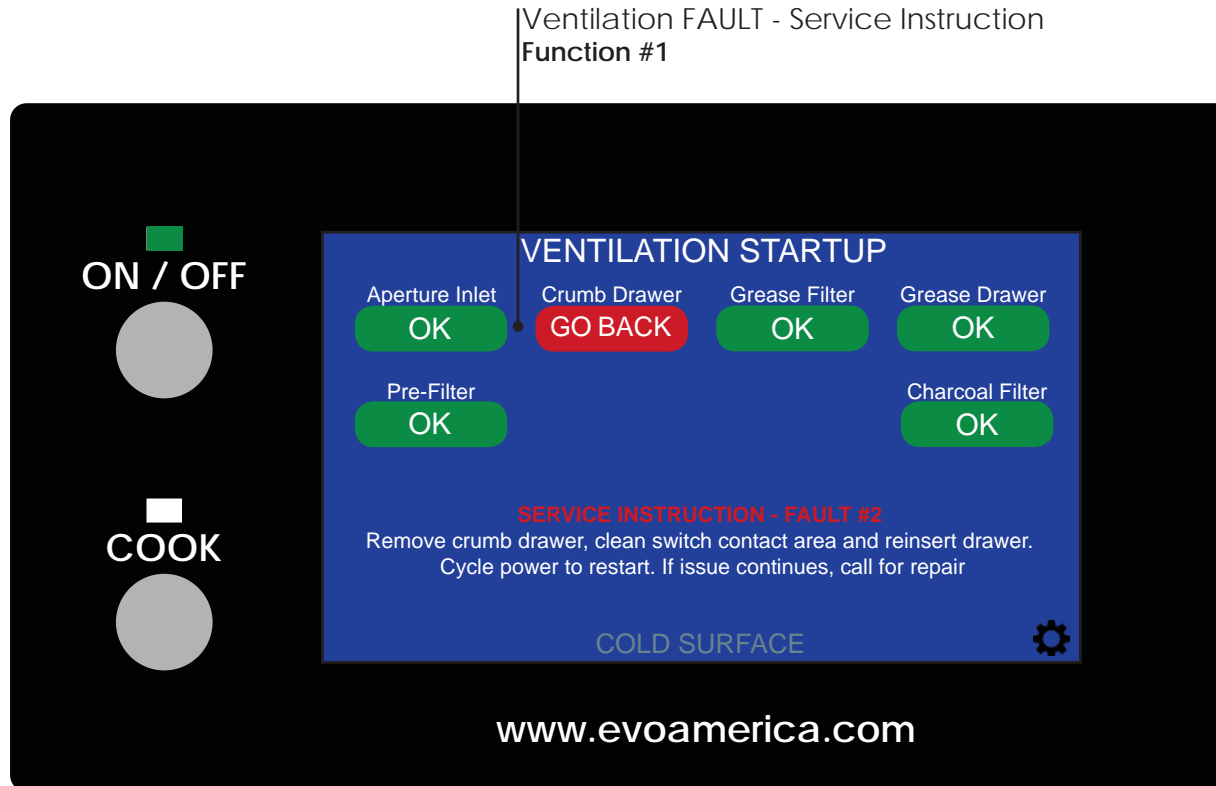

### FUNCTION

#1 When the FAULT button is pressed, a Service Instruction is shown that provides information to correct the fault. Once this information is read, press the GO BACK button to return to the previous screen.

### NOTE:

If more than one FAULT occurs, select each FAULT to view the Service Instruction. Press the GO BACK button to return to the previous menu.

To restart unit, once th fault is cleared, cycle the power OFF/ON.

For a list of ventilation faults and related service instructions, refer to Page 40.

## Cooktop Startup

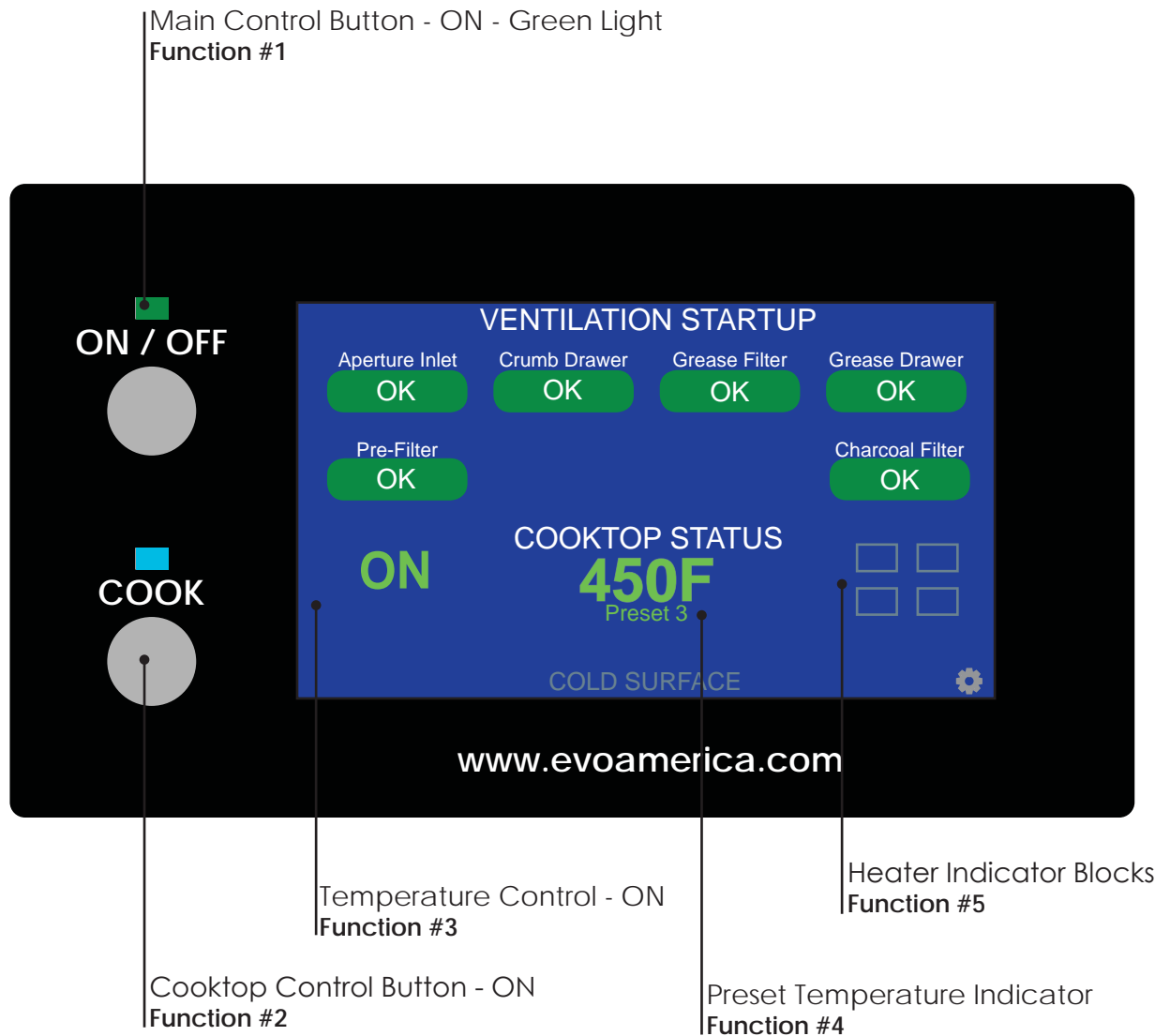

### FUNCTIONS

- #1 With ON/OFF button in ON position and the ventilation startup switch components showing OK, the COOK button becomes operational.
- #2 When the COOK button is pressed to the ON position, the light shows blue.
- #3 Cooktop Status temperature control becomes functional, and ON indicator shows green.
- #4 Temperature Presets are controlled from the Settings screen. The last preset configured under Settings will remain the default until changed.
- #5 Heater Indicator Blocks show active heaters in red outline (see note below).

#### NOTE:

The EVent® 48E has 4 electric heaters positioned under the cooking surface represented by the Heater Indicator Blocks. An active heater is represented by red color outlined block. Using intelligent heater control to maintain a set temperature, the system energizes only the area of cooking surface that requires heat, leaving the other heaters idle to conserve energy.



## Administration Settings - Overview

### FUNCTION

#1 To select the Administration Settings, press the gear icon in the lower right screen.

Choosing a feature jumps you to the related setup screen.

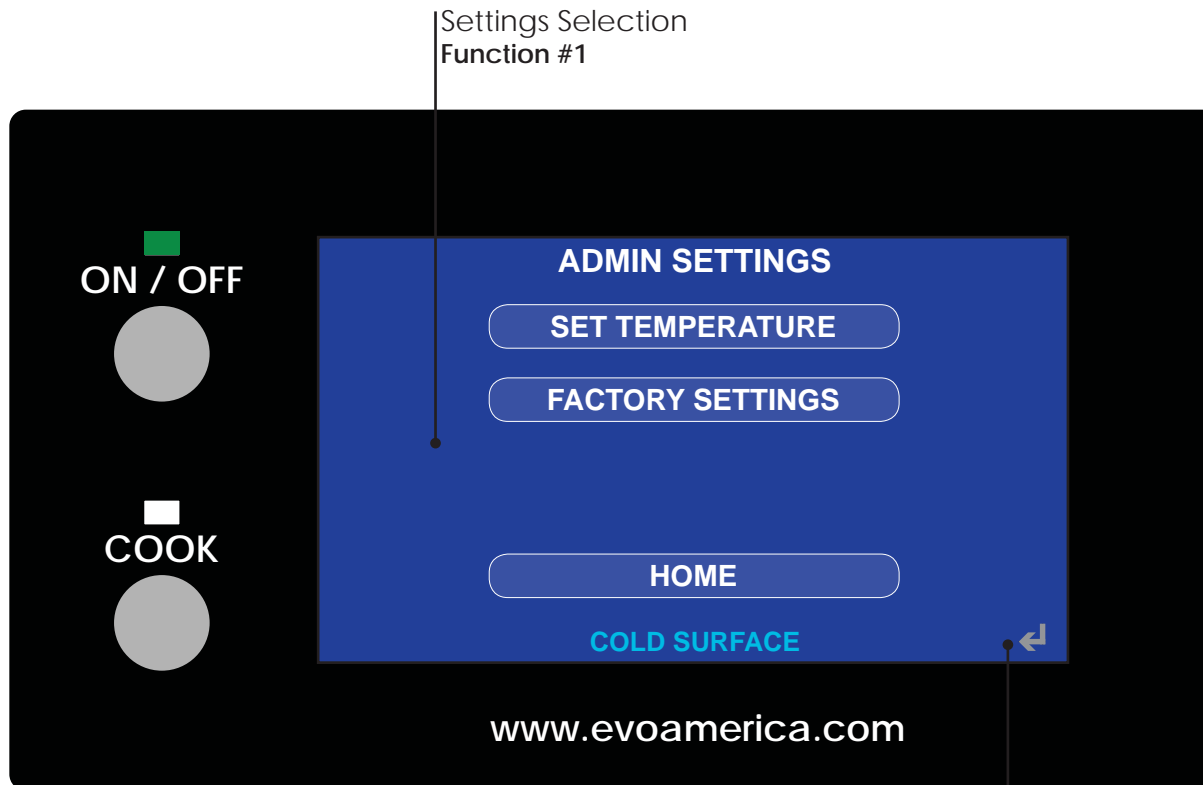

Settings Selection  
Function #1

Return To Previous Screen

## Administration Settings - Select Temperature Presets

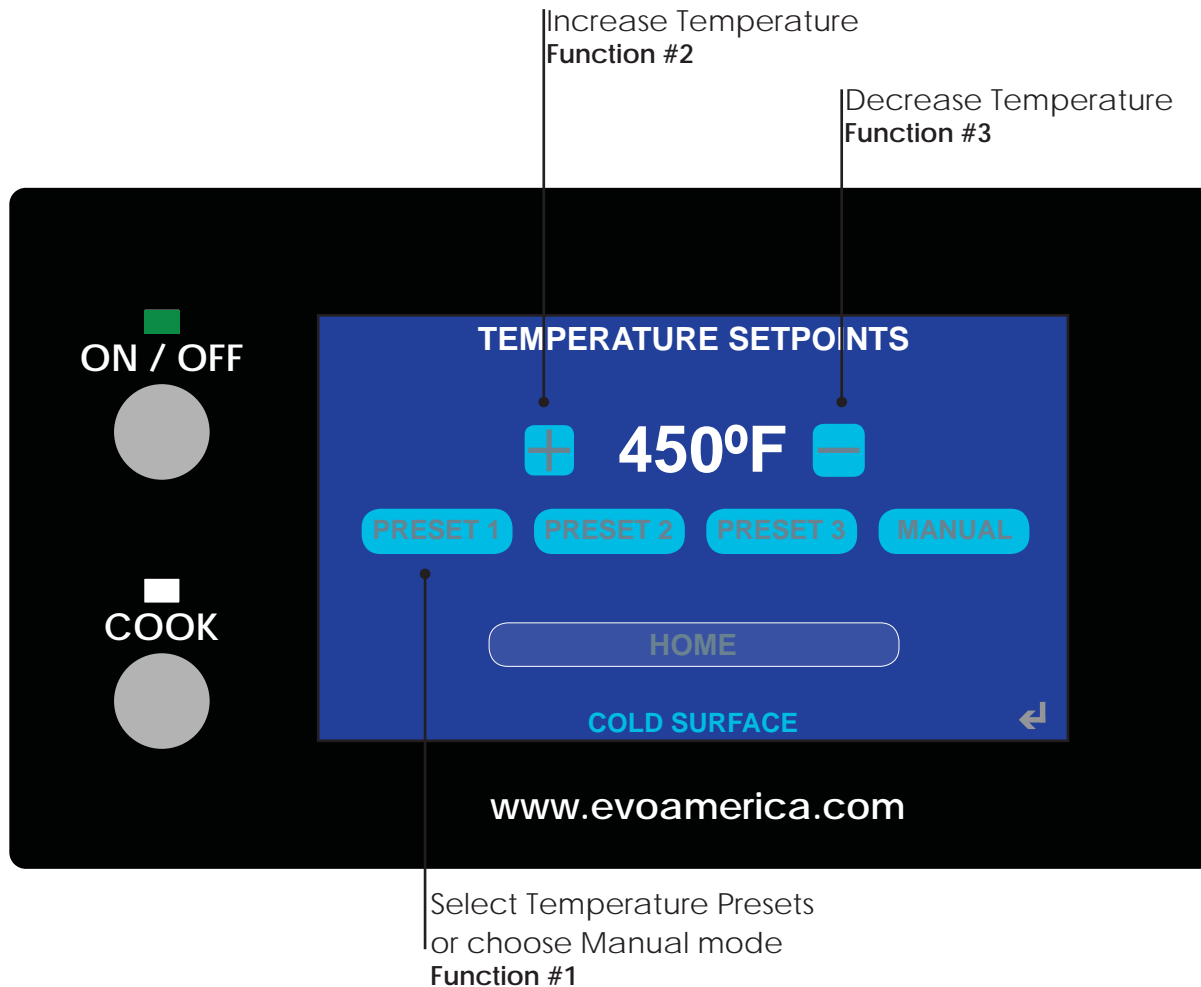

### FUNCTION

- #1 Select a temperature preset.
- #2 To increase temperature select the “+” button.
- #3 To decrease temperature select the “-” button.

### NOTE:

Previously selected temperature presets are stored in memory and recalled by pressing the respective preset button.

To change a preset, select a preset number and increase or decrease the temperature setting.

Temperature selections are available in increments of 25°F (4°C) from 150°F to 525°F (65°C to 288°C).

## Administration Settings - Select Temperature Presets

### FUNCTIONS

#1 A temperature preset will become available under Cooktop Status once it is selected from the Set Temperature Preset screen.

### NOTE:

The last preset configured under Settings will remain the default preset value until a new temperature preset is selected or until manual mode is selected.

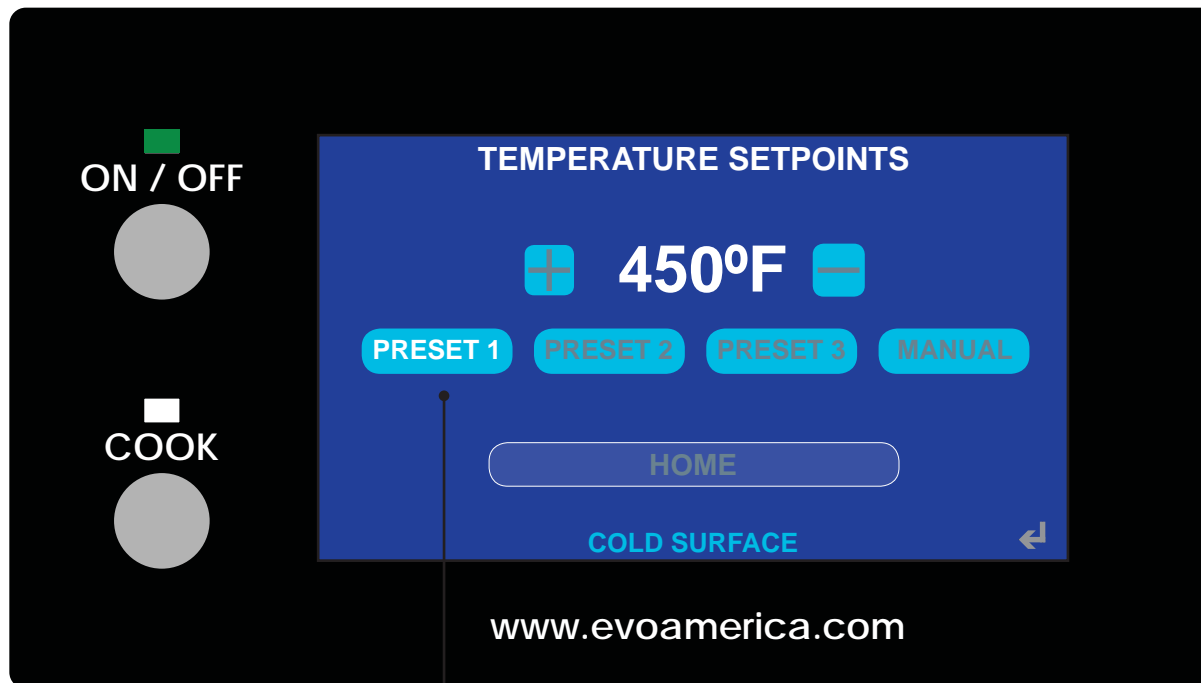

Preset Temperature Indicator  
Function #1

## User Settings - Use Manual Temperature

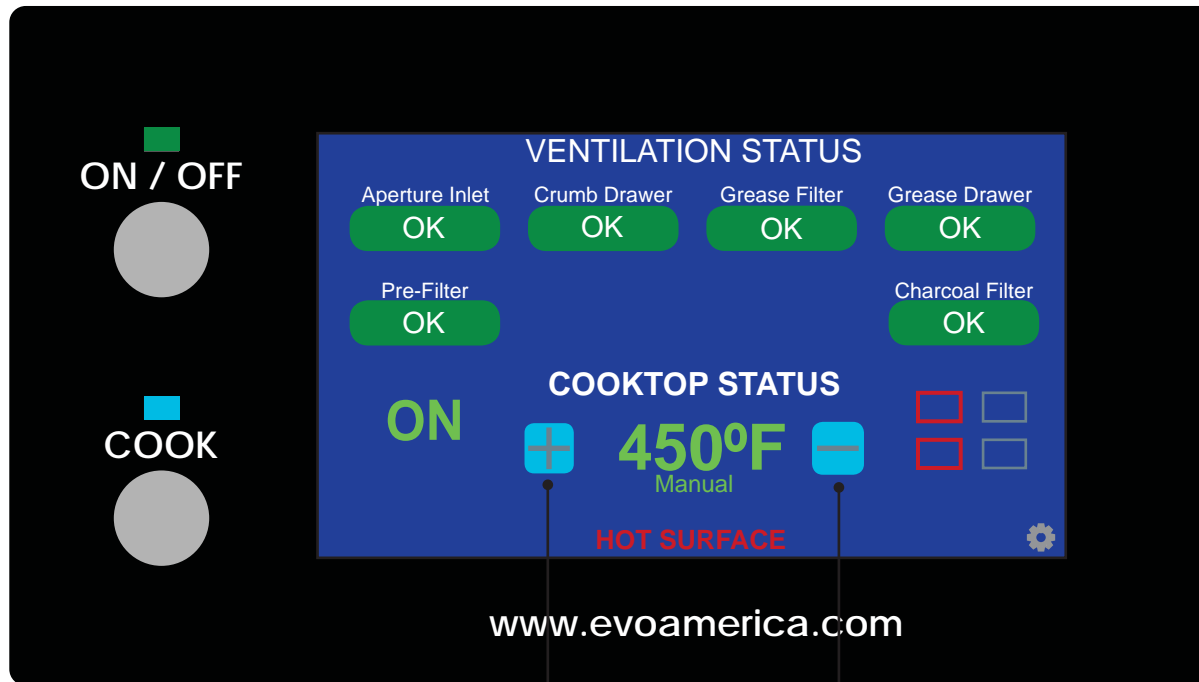

Temperature - Increase  
Function #1

Temperature - Decrease  
Function #2

### FUNCTIONS

To set temperature manually, select Manual Temperature mode from the Select Temperature Preset screen.

Once manual temperature is selected under Settings it shows green and the screen reverts to the Startup screen showing manual temperature control.

- #1 To increase temperature press the " + " button.
- #2 To decrease temperature press the " - " button.

### NOTE:

If manual temperature is the last selected control temperature under Settings, then it will remain the default value until a new temperature is selected.

## Factory Settings - Overview

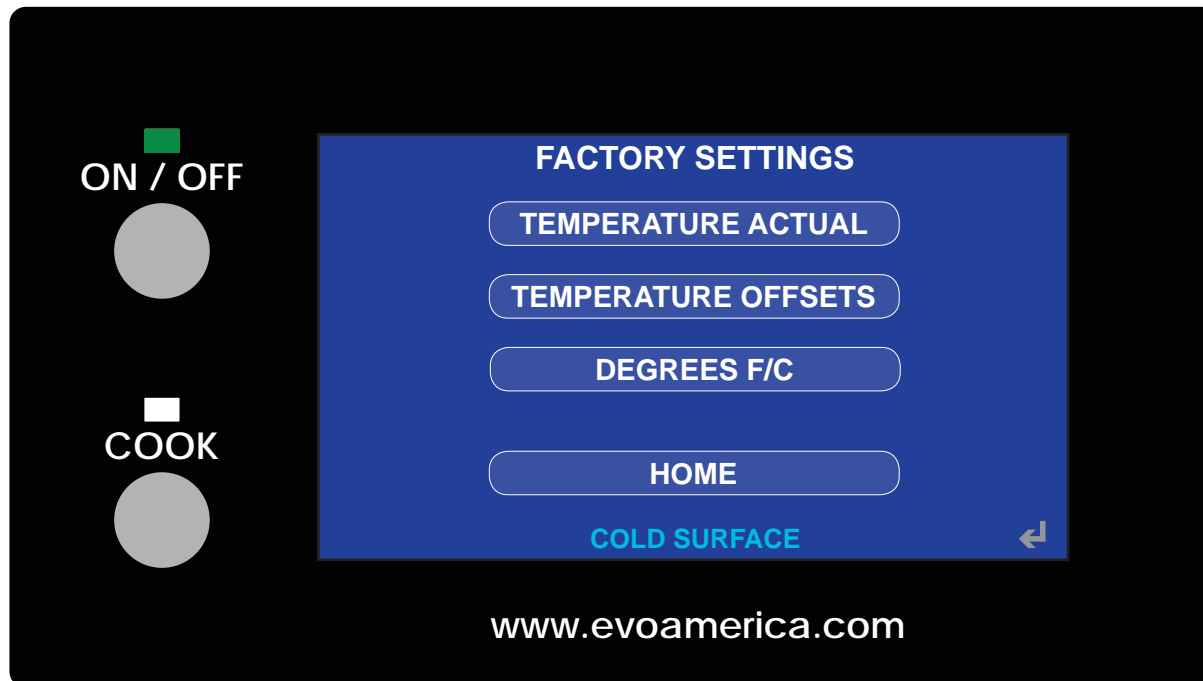

### FUNCTION

The factory settings control screen provides factory utilities for adjusting the setup parameters of the Event® 48E system.

### NOTE:

**These parameters are set at the factory and do not require adjustment. Only authorized factory service technicians should access these utilities.**

## Factory Settings - Actual Temperature

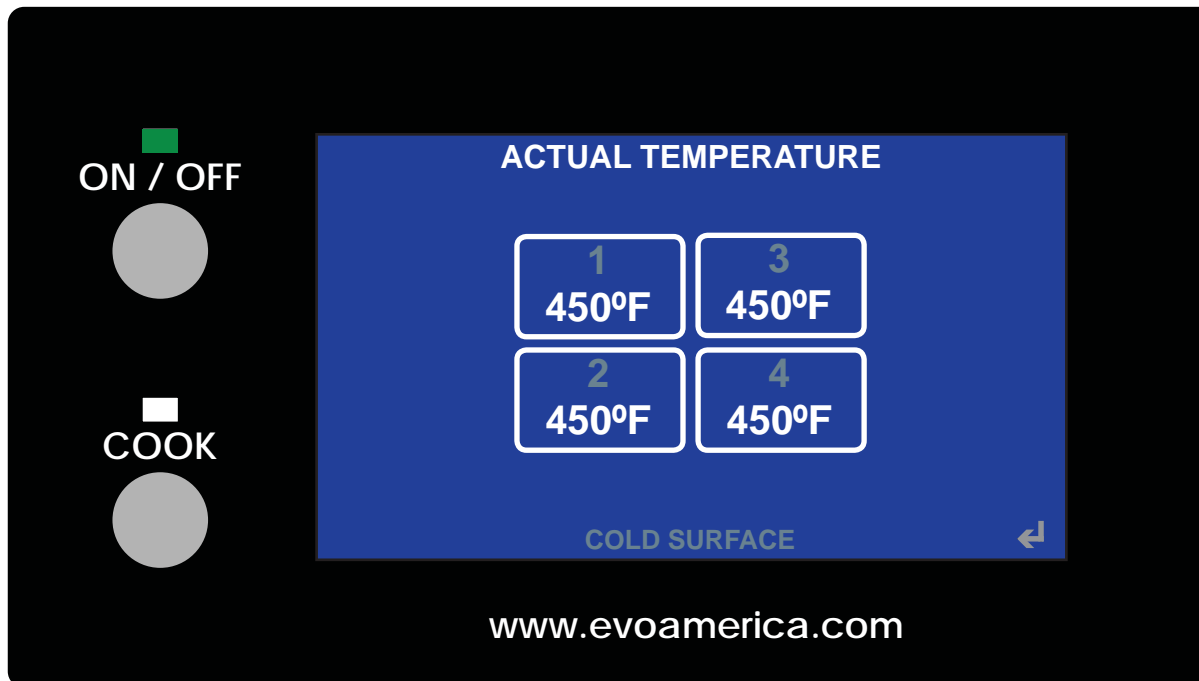

### FUNCTION

The actual temperature screen shows actual temperature at each heater zone location which also includes the offset value.

The factory setting allows accurate calibration of the actual cooking surface temperature to the calculated electrical heater temperature positioned under the cooking surface.

**Only authorized factory service technicians should use this utility to calibrate cooking surface temperature.**

## Factory Settings - Set Temperature Offsets

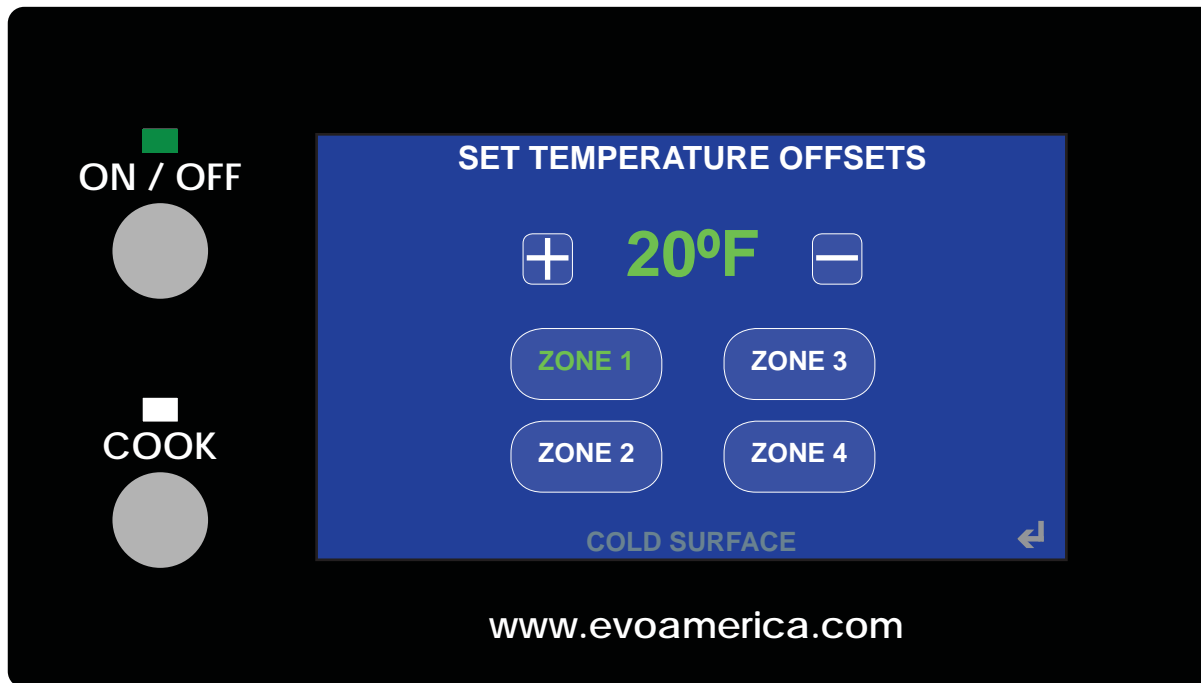

### FUNCTION

The temperature offset screen shows the offset temperature at each heater zone, and provides individual adjustment of each zone.

This factory setting allows calibration of the temperature carry-over calculation that provides accurate actual cooking surface temperatures.

**Only authorized factory service technicians should use this utility to calibrate cooking surface temperature.**

## Cleaning - Stainless Steel Chef-Side Panels and Toe Kick Panels

Establish a regular cleaning schedule. Any spills should be wiped off immediately.

1. Wipe exposed, cleanable stainless steel surfaces when cool with a mild detergent and warm water. Stubborn residue spots should be soaked with warm soapy water and rubbed clean with a terry cloth or paper towel. Dry thoroughly with a clean cloth.
2. Always rub stainless steel in the direction of the metal grain to prevent scratching. Use a stainless steel cleaner if you want a high shine. Never use abrasive scour pads or steel wool on stainless steel.
3. The control panel surface is made from a plastic material and requires more delicate cleaning. Use warm soap and water and a soft cloth. Do not use abrasive scour pads or solvent cleaners since these will scratch or cloud the surface.
4. Never spray the perforated areas or control panel with steam or water, this will allow moisture into the control cavity which could damage electrical components.



Always use non-abrasive cleaner when cleaning stainless steel panels to avoid scratching and dulling the surfaces. Never use steel wool on stainless steel.



## Cleaning - Decorative Tabletop, Side Panels, and Granite Surfaces

Establish a regular cleaning schedule. Any spills should be wiped off immediately.

1. Using a terry cloth or paper towel, wipe the seating area and under counter side panels with warm soap and water, or a mild detergent suitable for the particular finish used on your EVent® teppanyaki table. In general, never use abrasive scour pads or corrosive cleaners as these will dull or destroy the finish of most decorative tabletop and side panel materials.
2. To maintain the granite surfaces surrounding the cooking griddle, use a terry cloth or paper towel with warm soap and water or a mild detergent.
3. To achieve a high luster finish on the granite surfaces, first remove heavy soil with warm soap and water, followed by a glass cleaner such as Windex® or a solution of water and vinegar.

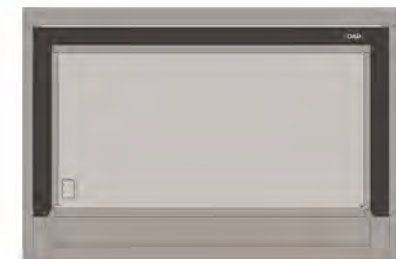

Always use a non-abrasive cleaner when cleaning decorative surfaces including the seating area and side panels to avoid scratching, dulling or damaging the surfaces.

## Cleaning - The Griddle Surface

There are several methods for cleaning the griddle cooking surface. The following guidelines are offered as a 'best practice' method for the EVent® 48E cooking surface.

1. Press the COOK button on the Control Panel to turn off the cooking surface. The blue LED indicator light will be off.
2. Press the OFF button on the Control Panel to turn off the ventilation system. The green LED indicator light will be off.
3. Using a scraper or spatula, scrape and remove loose debris by sweeping into the spillover slot.
4. While the cooking surface is still warm, scrub the surface with a grill pad in a circular motion, using a grill pad holder to maintain even pressure on the pad.
5. For heavy carbon buildup, it may be necessary to use a grill screen in combination with the grill pad.
6. Thoroughly wipe the surface with a terrycloth towel to remove any debris from the grill pad and grill screen.
7. Apply a thin layer of vegetable oil over the entire surface with a clean cloth to condition the steel surface and help prevent rusting.

**SEE APPENDIX 2 FOR DETAILED GRIDDLE SURFACE CLEANING INSTRUCTIONS**



**CAUTION:** Do not pour water onto hot griddle surface when the ventilation fan system is on. The water vapor will be pulled into the vent aperture and will degrade and/or damage the ESP unit.

Steel Griddle  
Cooking Surface



Cleaning handle,  
Pad and screen.



Scraper

## Cleaning - Ventilation Inlet Aperture

The Ventilation Aperture is located on the chef-side of the EVent® 48E, and is removable for easy cleaning.

Depending on the amount and type of foods being cooked, daily cleaning may be required.

1. Using two hands, pull the aperture out of the inlet duct slot.
2. Clean the aperture with warm soap and water or a non-corrosive detergent. A good method is to place the aperture over a 3-bin sink to wash, then rinse and dry thoroughly.
3. **IMPORTANT** - Read the following page titled, "Cleaning - Ventilation Inlet Duct" before attempting to clean the duct under the aperture.

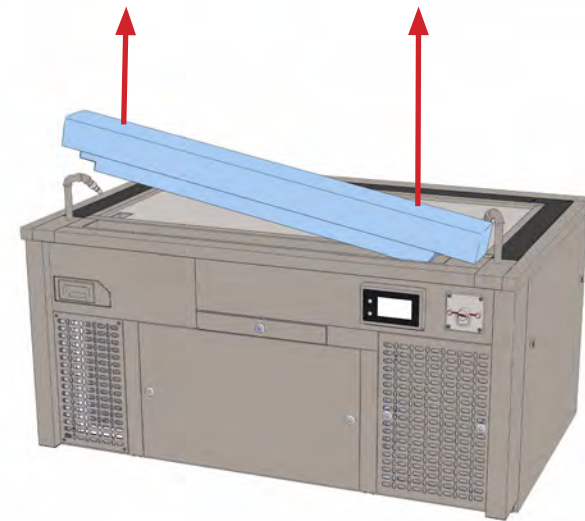

**CAUTION:** When cleaning inlet duct, do not disrupt, flex or bend the fire suppression fusible link or the fire suppression system. Failure may cause a discharge, damaging the unit and voiding the EVent® 48E warranty.

## Cleaning - Ventilation Inlet Duct

Within the Ventilation Inlet Duct is the fire suppression fusible link that engages the fire suppression system. If there is fire on the cooking surface and the fire enters the inlet aperture, the fusible link is designed to melt at temperatures above 280°F and discharge the fire suppression system.

1. Remove the ventilation inlet duct aperture and inspect the inlet duct for grease and food debris. Inside the inlet aperture is the fire suppression fusible link assembly (see Illustration 1 & 2).
2. Clean the aperture with standard soap and water or a non-corrosive detergent. Using paper towels or a terry cloth towel, wipe all grease and food debris clean from the inlet duct.
3. Use extreme caution and do not disrupt the fusible link located inside the ventilation inlet duct. Gently clean the fusible link and link wire cable using moist towels or a finely textured brush.
4. Do not use rigid tools for cleaning the inlet duct and do not chip or scrape around the fusible link assembly. Doing so may cause the fire suppression system to discharge.



**CAUTION:** Never use steam cleaning equipment to clean the EVent® unit. Never use excessive amounts of water or ice for cleaning the cooking surface. Doing so will cause steam to enter the inlet aperture and disrupt the fusible link which may discharge the fire suppression system causing damage and voiding the EVent® 48E warranty.

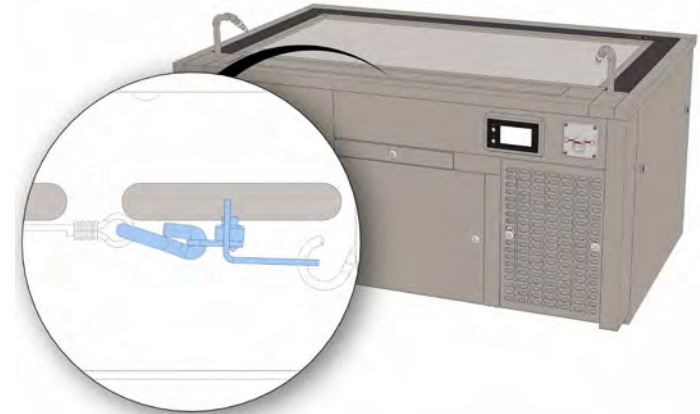

Illustration 1



**CAUTION:** Never use steam cleaning equipment to clean the ventilation inlet duct. Never use excessive amounts of water or ice for cleaning the cooking surface. Doing so will cause steam to enter the inlet aperture and the fire suppression fusible link will become damaged resulting in a discharge of the fire suppression system causing damage and voiding the warranty.

Illustration 2



**CAUTION:** The fusible link is installed under tension to a wire cable that engages the fire suppression system. The link is designed to melt at a temperature of 280°F which will release tension to the wire cable and trigger the fire system. Never use steam cleaning equipment or deglaze the cooking surface with water, or use corrosive cleaners to clean ventilation inlet duct as this will cause damage to the fusible link resulting in a discharge of the fire system.

## Cleaning - The Crumb Drawer

The Crumb Drawer is secured by a hex key and located on the chef-side just below the aperture. It is designed to collect some of the food and grease debris that is pulled into the aperture. Under normal cooking conditions, the crumb drawer should be washed weekly.

Depending on the food being cooked or the frequency of cooking, you may extend cleaning cycles beyond one week to every other week.

1. Using the supplied Hex Key, unlock the crumb drawer and pull forward to remove.
2. Clean the crumb drawer with standard soap and water or a non-corrosive detergent. For fast cleaning, wash the drawer in a commercial dish washing machine. Wash as necessary to remove all grease buildup.
3. Reinsert the clean and dry crumb drawer and make sure the drawer makes contact with the plunger switches on the back wall of the aperture duct. You will notice a slight 'click' when the drawer is reinserted and makes contact with the switches.

**THE CRUMB DRAWER LATCH ENGAGES A SLOT IN THE BOTTOM OF THE APERTURE DUCT. TO ENSURE THE LATCH IS LOCKING PROPERLY, LOOK INTO THE BOTTOM OF THE APERTURE DUCT AND MAKE SURE THE LATCH IS ENGAGING THE APERTURE DUCT SLOT**

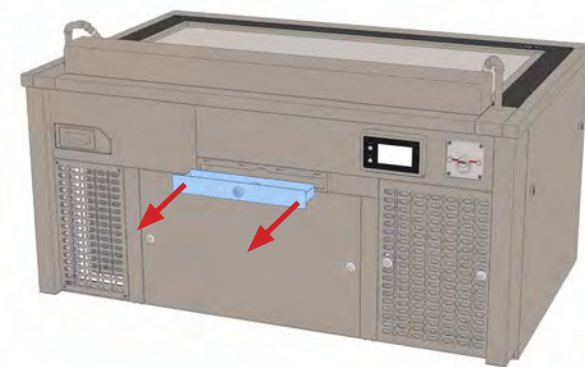

## Cleaning - The Grease Filter

The grease filter is a stainless steel baffle filter that captures airborne grease. Under routine cooking conditions, the grease filter should be washed once a week or replaced with a clean standby filter as necessary.

Depending on foods being cooked or the frequency of cooking, you may extend cleaning cycles beyond once a week to every other week.

1. From the chef-side of the table, remove the right side perforated panel by unlatching the middle latches using the 8mm Hex Key. Set the perforated panel aside. Behind the perforated panel is the door to the grease filter box. Unlatch the door using the 8mm Hex Key. (see Illustration 1).
2. With the grease door unlatched, tilt the door outward and lift upward to release the door from the bottom metal channel. When the door is forward of the metal channel, again tilt the door outward to remove the door. Set the door aside, and remove the grease filter by pulling it forward. (see Illustration 2 & 3).
3. Clean the grease filter by soaking in a degreaser solution and rinsing clean. For faster cleaning, wash the filter in a commercial dish washing machine. Wash as necessary to remove all grease buildup.
4. Thoroughly dry the grease filter before reinserting into the grease filter enclosure. Alternatively, have an extra standby filter to facilitate fast cleaning.



**CAUTION:** Use only the stainless steel baffle-type grease filter supplied by Evo. Failure to do so may cause damage to the ESP unit and void the EVent® 48E warranty.

**DURING GREASE FILTER CLEANING, ALSO CLEAN THE GREASE BOX ENCLOSURE. SEE SECTION CALLED 'CLEANING - GREASE BOX ENCLOSURE'**



**Note:** With the grease door unlatched, tilt the door outward and lift upward to lift the door from the bottom metal channel. When the door is forward of the metal channel, tilt the door outward to remove.





## Cleaning - The Grease Filter Enclosure Part 1

With the grease filter removed from its enclosure, wipe the inside of the enclosure and all duct surfaces to remove grease and food particles.

For fast cleaning, use a non-corrosive, non-toxic spray degreaser to wet the inside surfaces, then wipe clean using paper towels or a terrycloth towel.

1. With the grease filter removed, remove the right-side support bracket, grease filter slotted pan, and grease filter bottom drawer for cleaning. Clean with a non-corrosive non-toxic spray degreaser, or wash these parts in a commercial dish washing machine.
2. Spray the inside surfaces of the grease enclosure and associated connecting ducts with a non-corrosive non-toxic cleaner.
3. Wipe the enclosure and all duct surfaces free of grease and food particles using paper towels or a terrycloth towel.
4. Thoroughly dry all surfaces and ensure there is no moisture or food particles remaining in the enclosure or connecting ducts.



**CAUTION:** When cleaning the grease filter enclosure, use care not to disrupt the air tube or allow food particles to enter the air tubes (do not wipe the end of the air tube which may cause grease debris to clog tube).

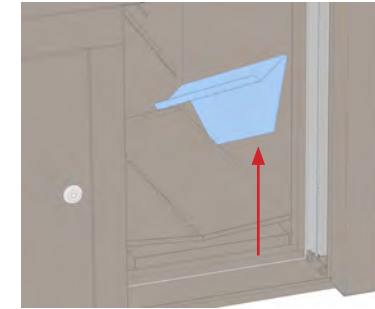

**Step 1:** Remove the support bracket, lifting from the front and tilting upward. To reinsert, tilt the bracket toward the rear and push down in the front.

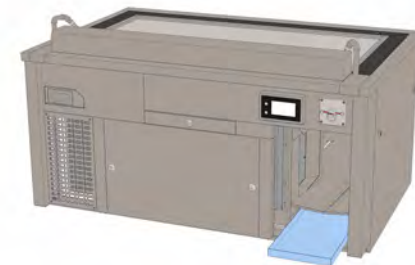

**Step 2:** Remove the bottom drawer from underneath the slotted pan. Lift the slotted pan and then remove the bottom drawer by lifting and pulling forward.



**Step 3:** With the bottom drawer removed, tilt the slotted pan right and slide forward.

## Cleaning - The Grease Filter Enclosure Part 2

With the grease filter enclosure clean, make sure the grease filter, support bracket, slotted pan, grease drawer, and door are clean and ready for reassembly.

7. Reassemble the grease filter support bracket and grease filter enclosure bottom pan the reverse of removal. Use special care to insert each component and make sure there is no damage or disruptions to the air tube.
8. Reinsert the grease drawer and make sure the drawer makes contact with the plunger switches on the back wall of the enclosure. You will notice a slight 'click' when the drawer is reinserted into the enclosure and makes contact with the switches.
9. Install a clean and dry grease filter and make sure the filter makes contact with the two plunger switches on the back wall of the enclosure.
10. Reinsert the grease enclosure door by first placing the door into the bottom metal channel, then tilting the door forward into the door frame. Using the 8mm hex key, turn the latch to secure the door into the door frame.
11. Reinstall the perforated exterior panel. Using the 8mm hex key, turn both latches and secure the panel into place.

**WHEN CLEANING THE GREASE FILTER ENCLOSURE, USE A FLASHLIGHT TO VISUALLY INSPECT THE ENCLOSURE. LOOK INTO THE CONNECTING DUCTS TO ENSURE THERE IS NO REMAINING GREASE RESIDUE OR FOOD PARTICLES. WIPE ALL INTERNAL LEDGES AND DUCT SEAMS CLEAN.**

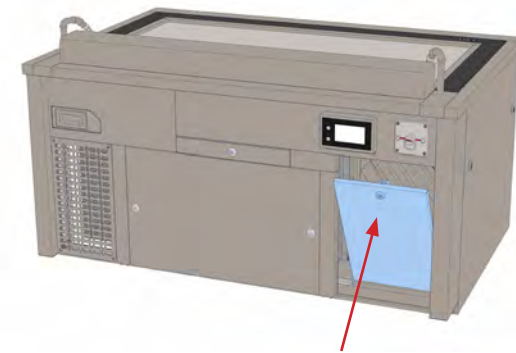

**Note: To reinsert the grease door, first place the door into the bottom metal channel, then tilt the door forward into the door frame. Using the 8mm hex key, turn the latch to secure the door into the door frame.**

**Reinstall the perforated exterior panel. Using the 8mm hex key, latch the panel into place.**



## Cleaning - The Electrostatic Precipitator (ESP) Part 1

The ESP 'Unicell' Filter is a electrically charged ionizing filter that captures airborne grease which is not captured by the primary grease filter. Under normal cooking conditions, the ESP filter should be washed weekly or replaced with a fresh clean standby filter of the same type.

Depending on the food being cooked or the frequency of cooking, you may extend cleaning cycles to every other week or every month.

1. Using the 8mm hex key, unlock both latch locks and remove the chef-side access panel.
2. Using the hex key, unlock both latch locks on the ESP door and swing the door open to the left.
3. With the ESP door open, remove the ESP filter from its enclosure by pulling outward on the ESP handle with one hand while lifting and supporting the ESP filter with the other hand.
4. Clean the ESP filter by soaking in a degreaser solution and rinsing clean. For faster cleaning, wash the filter in a commercial dish washing machine.
5. Thoroughly dry the ESP filter before reinserting into the ESP filter enclosure. Alternatively, have an extra standby ESP filter that is clean and dry to facilitate fast cleaning.

**IF THE ESP FILTER IS REINSTALLED AND AN ARCING OR SNAPPING NOISE IS HEARD, IMMEDIATELY TURN OFF THE VENTILATION SYSTEM AND REMOVE THE FILTER TO ENSURE IT IS CLEAN AND DRY**



**CAUTION:** Do not reinstall a wet ESP filter. Doing so will cause electric arcing and damage the ESP Unicell voiding the EVent® 48E warranty.

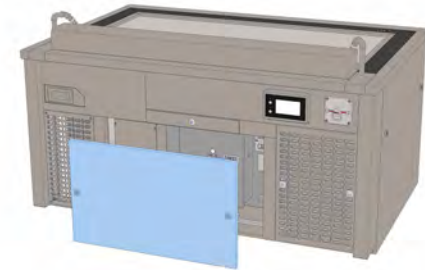

## Cleaning - The Electrostatic Precipitator (ESP) Part 2

The ESP 'Unicell' Filter requires special care and handling, and cleaning. Be careful to never touch any internal components of the ESP filter and particularly do not touch the ionizing wires.

The ESP filter is best cleaned in a commercial dishwasher, and dried in warm air. It is important the ESP be washed and completely dry before reinserting back into the ESP enclosure.

1. Always handle the ESP filter by the integral filter handle, and carefully support the ESP filter when reinserting back into the ESP enclosure (see Illustration 1).
2. Do not touch or disturb the ESP filter internal ionizing collector fins or ionizing wires (see Illustration 2).
3. Reinsert the ESP by placing one hand on the ESP handle, and supporting the underside of the ESP filter with the other hand.

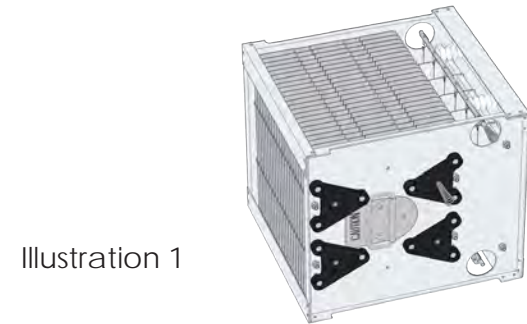

Illustration 1

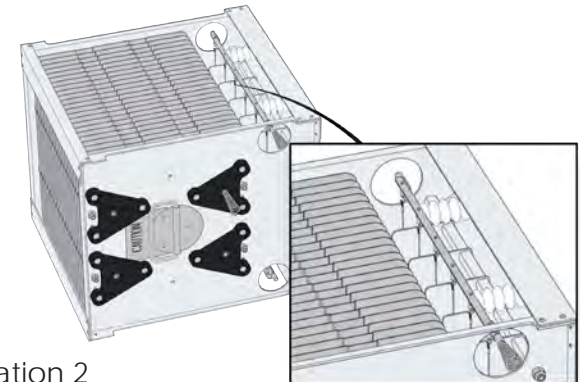
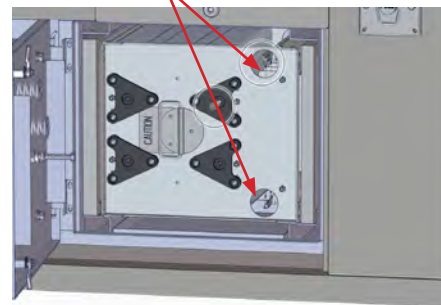

Illustration 2

**MAKE SURE THE ELECTRICAL CONTACT SPRINGS ARE FACING TOWARD THE RIGHT SIDE OF THE ESP ENCLOSURE.**

**CLEAN ALL OIL AND GREASE DEBRIS FROM THE SPRINGS AND THE ESP DOOR ELECTRICAL TERMINALS. FAILURE TO CLEAN ELECTRICAL TERMINALS AND SPRINGS WILL CAUSE THE ESP TO MALFUNCTION AND POSSIBLE DAMAGE TO THE EVENT UNIT.**

ESP Contact Springs



ESP inserted correctly with springs facing right

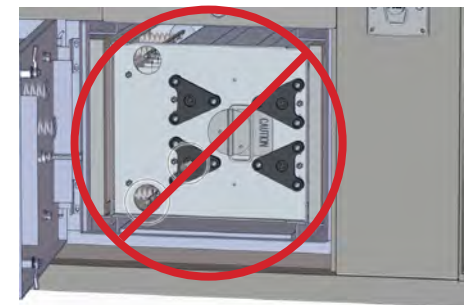

ESP inserted incorrectly with springs facing left



**CAUTION:** Do not reinstall a wet ESP filter. Doing so will cause electric arcing and damage the ESP Unicell voiding the EVent® 48E warranty.

## Cleaning - The Electrostatic Precipitator Aluminum Pre-Filter

Located inside the ESP filter enclosure is an expanded aluminum Pre-Filter that is designed to capture food debris that may have passed through the primary grease filter. With normal cooking conditions, the Pre-Filter should be washed weekly or replaced with a clean standby filter of the same type.

Depending on foods being cooked or the frequency of cooking, you may extend cleaning cycles beyond one week to every other week.

1. Using the supplied 8mm hex key, unlock both latch locks and remove the chef-side access panel.
2. Using the hex key, unlock both latch locks on the ESP door and swing the door open to the left.
3. With the ESP door open, remove the expanded aluminum Pre-Filter.
4. Clean the Pre-Filter by soaking in a degreaser solution and rinsing clean. For fast cleaning, wash the filter in a commercial dish washing machine. Wash as necessary to remove all grease buildup.
5. Thoroughly dry the Pre-Filter before reinserting back into the ESP enclosure. Alternatively, have an extra standby filter that is clean and dry to facilitate faster cleaning.

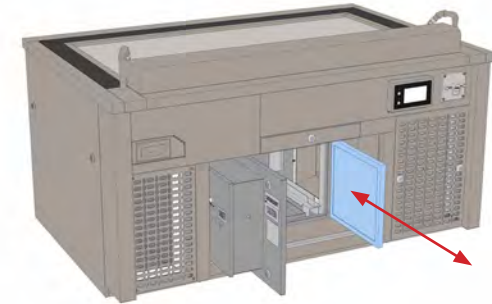

**Note:** With the ESP door open, slide the Aluminum Pre-Filter rearward and remove. To reinstall, place the filter into the top and bottom filter channel and slide forward.



**CAUTION:** Always install the Aluminum Pre-Filter on the right side of the ESP enclosure. Failure to install the pre-filter on the right side of the ESP may damage the unit and void the EVent® 48E warranty.

## Cleaning - The Electrostatic Precipitator Bottom Pan

Located inside the ESP enclosure under the ESP filter is a metal pan designed to contain overflow grease not collected by the ESP filter. With normal cooking conditions, the Bottom Pan should be washed monthly or as needed.

1. Using the supplied 8mm hex key, unlock both latch locks on the chef-side access panel and set aside the panel.
2. Using the 8mm hex key, unlock both latch locks on the ESP door and swing the door open to the left.
3. Remove the ESP Filter.
4. Located under the ESP filter is the bottom pan. Remove the pan and wash with soap and water and rinse dry clean. For faster cleaning, wash the pan in a commercial dish washing machine. Wash as necessary to remove all grease buildup.
5. Reinsert the Bottom pan the reverse of removal.

**IF THE BOTTOM PAN HAS A COLLECTION OF GREASE, THIS IS AN INDICATION THE ESP UNICELL FILTER IS OVERBURDENED BY GREASE AND SMOKE AND REQUIRES MORE FREQUENT CLEANING**

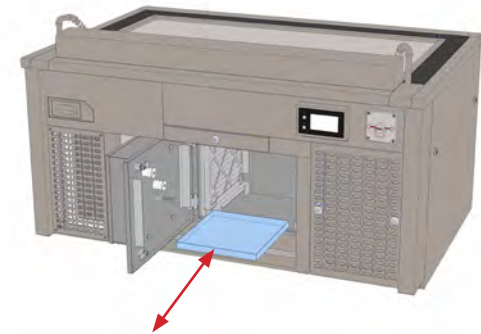

**Note: With the ESP filter removed, lift and remove the bottom pan and clean as necessary.**

## Replacing - The Disposable Charcoal Filter

Located inside the ESP filter enclosure is a disposable charcoal filter that is designed to retain a portion of the cooking odors passing through the ventilation system. With normal cooking conditions, the charcoal filter should be replaced with a fresh, clean filter monthly.

Depending on the food being cooked or the frequency of cooking, the charcoal filter may be changed more frequently.

1. Using the 8mm hex key, unlock both latch locks and remove the chef-side access panel.
2. Using the 8mm hex key, unlock both latch locks on the ESP door and swing the door open to the left.
3. With the ESP door open, remove the ESP filter from its enclosure by pulling outward on the ESP handle with one hand while lifting and supporting the ESP filter with the other hand.
4. Remove the disposable charcoal filter located to the left of the ESP by pulling outward.
5. Replace with a new clean charcoal filter. Reinsert the ESP by placing one hand on the ESP handle, and supporting the underside of the ESP filter with the other hand.

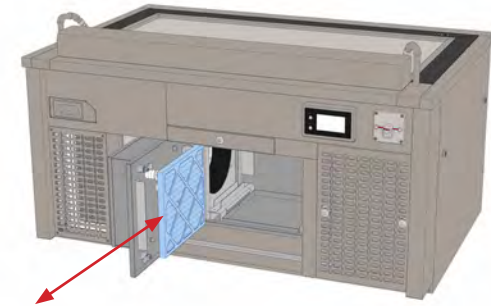

**Note:** With the ESP door open, slide the Charcoal Filter rearward and remove. To reinstall, place the filter into the top and bottom filter channels and slide forward.

The Charcoal Filter has a white side and a black colored side. Place the white side inward toward the ESP filter.



**CAUTION:** Always install the Charcoal Filter on the left side of the ESP enclosure. Failure to install the charcoal filter on the left side of the ESP may damage the unit and void the EVent® 48E warranty.

## TROUBLESHOOTING ISSUES

This section describes how to solve common problems you may encounter when using your EVent® 48E FMS Display Cooking Station. Many problems have simple solutions.

### #1 On/Off Button Will Not Respond

1. Ensure the unit is plugged into a correct voltage and amperage receptacle. Have a certified electrician check the cord wiring has not become dislodged from inside the plug thereby preventing a secure electrical connection.
2. Check the electrical breaker panel to ensure the circuit breaker has not tripped. If it has been tripped, reset the breaker by switching to the "On" position.
3. Have a certified electrician check the EVent® Main Disconnect Switch inside the high voltage panel is in the ON position (The red switch should be in the horizontal position).

### #2 The Fan Starts Then Stops After 5-10 Seconds

1. Ensure all duct cabinet doors are securely closed. Check the ESP door and ensure both latches are properly closed. Check the grease box door is securely closed.
2. Check all filters are clean and the paper charcoal filter is new and clean.
3. Check the air tubes in the grease box for obstructions or grease build-up inside the tube preventing proper air sensing. If necessary, clean air tubes with a pipe-cleaner (it may be necessary to remove the right side panel and remove the rubber tubing from the back side of the grease box air tube to properly clean the tube. Once clean, reinstall the rubber tubing).

### #3 The Fan Starts Then Stops When Cooking

1. Check all points in Issue #2 above. If issue persists, check the following:
2. Check the grease box bottom pan is making good contact with the presence switch positioned in the lower back portion of the grease box.
3. Check the Charcoal Filter is making good contact with the presence switch positioned in the upper back portion of the charcoal filter guide slot.
4. Check the Charcoal Filter is clean and new. An old paper charcoal filter may become deformed and not make good contact with the presence switch.

### #4 The Display Appears Functional But The Fan Does Not Start

1. If the display appears functional when the ON button is pressed but the fan does not start, and if the COOK button is pressed and it appears the heaters are cycling on/off (see illustration page 14), then a Presence Switch is damaged and will require replacement.
2. A damaged Presence Switch is most likely to occur
3. If the ESP Green light on the outside of the ESP door is blinking, this is an indication the ESP Unicell is either soiled, is not making proper electrical contact with the ESP door terminals, or the Unicell is damaged. DO NOT OPERATE THE EVent® UNIT IS THE ESP LIGHT IS CONTINUOUSLY BLINKING. A service call must be reported to resolve this issue.



## TROUBLESHOOTING ISSUES

### #5 The Display Is Grey or The Display Does Not Respond

1. Ensure the display control panel is not broken or damaged. If the display is cracked or damaged, the previous settings at the time the display was damaged will be frozen and no other selections can be made. A service call must be reported to replace the damaged display.
2. If the display is not damaged or cracked, then a grey or unresponsive display is an indication the ESP may be malfunctioning. If the ESP is not clean or the electrical terminals on the ESP door are soiled and not making proper contact with the ESP Unicell, static electricity may develop inside the ESP cabinet and damage the system controls.
3. If the ESP Green light on the outside of the ESP door is blinking, this is an indication the ESP Unicell is either soiled, is not making proper electrical contact with the ESP door terminals, or the Unicell is damaged. DO NOT OPERATE THE EVENT UNIT IS THE ESP LIGHT IS CONTINUOUSLY BLINKING. A service call must be reported to resolve this issue.

### #6 The Upper Left Side Heater Is Over Heating

1. This is an indication the Heater Control Board is damaged and requires replacement. A service call must be reported to resolve this issue.
2. Cause of this issue is an indication the ESP may be malfunctioning. If the ESP is not clean or the electrical terminals on the ESP door are soiled and not making proper contact with the ESP Unicell, static electricity may develop inside the ESP cabinet and damage the Heater Control Board. If the ESP Green light on the outside of the ESP door is blinking, this is an indication the ESP Unicell is either soiled, is not making proper electrical contact with the ESP door terminals, or the Unicell is damaged. DO NOT OPERATE THE EVENT UNIT IS THE ESP LIGHT IS CONTINUOUSLY BLINKING. A service call must be reported to resolve this issue.

### #7 The COOK Button Is On But The Heaters Are Not Heating

1. This is an indication the Heater Control Board may need to be reset. Momentarily turn power to the unit Off then ON from the main circuit breaker or by unplugging the unit from the receptacle.
2. If there is a large temperature difference than what is desired, ensure the unit has enough time to reach its set point (From a cold startup, the unit will take approximately 20 minutes to reach 450F). If large temperature difference continues, ensure the High Limit Switch has not been lowered from its Factory Setting of 570F. ( The High Limit Switch is located inside the units high-voltage panel and must only be inspected or serviced by a licensed service technician). If this issue persists, a service call must be reported.

### #8 The Display Shows Red Fault Indicators

1. The Event® 48E has a built-in diagnostics system on the control panel display. If the On/Off button is pressed and the ventilation fan does not start, then a red FAULT light will highlight the troubled ventilation component. When you depress the FAULT light, the display screen shows a helpful repair instruction to correct the issue. Listed on the following page is a list of ventilation systems faults and the corrective action.  
(See the following page for a description on Fault Indicators).

## TROUBLESHOOTING ISSUES

### CONTROL PANEL DISPLAY - FAULT INDICATORS

#### **FAULT #1 - Aperture Inlet Duct**

Remove aperture inlet air duct, inspect switch contact area, reinsert aperture.  
Cycle power to restart.

#### **FAULT #2 - Crumb Drawer**

Remove crumb drawer, clean switch contact area and reinsert drawer.  
Cycle power to restart.

#### **FAULT #3 - Grease Filter**

Open grease filter box. Remove grease filter, inspect switch contact area and reinsert filter and door.  
Cycle power to restart.

#### **FAULT #4 - Grease Drawer**

Open grease filter box. Remove grease filter, slotted pan and grease drawer.  
Inspect switch contact area and reinsert drawer, tray and filter door.  
Cycle power to restart.

#### **FAULT #5 - Pre-Filter**

Open ESP door, check aluminum pre-filter switch contact area. Reinsert filter.  
Cycle power to restart.

#### **FAULT #6 - Charcoal Filter**

Open ESP door, check charcoal filter switch contact area. If there is an indentation on the charcoal filter paper frame where it contacts the switch, this may cause the fan to stop running.  
Rotate the charcoal filter to the opposite end of the paper frame that does not have an indentation and reinsert the filter. If the problem persists, then replace the filter.  
Cycle power to restart.



## REQUIRED EVENT SYSTEM MAINTENANCE SCHEDULE

USE AND MAINTENANCE SHALL BE IN ACCORDANCE WITH THE STANDARD FOR VENTILATION CONTROL AND FIRE PROTECTION OF COMMERCIAL COOKING OPERATIONS, N.F.P.A. 96 (current edition)

### 1-WEEK OWNERS VENTILATION DUCT AND FILTER MAINTENANCE

|   |
|---|
| Remove all metal filters and wipe/wash all internal duct areas including ESP enclosure and clean ESP door electrical terminals.   |
| Thoroughly clean entire internal duct system, and clean air sensing tubes in grease box.<br>Ensure there is no oil or grease remaining in between duct channels and around presence switches. |
| Wash Stainless Steel Grease Filter.   |
| Wash Grease Box Grease Filter Bracket, Bottom Support and Bottom Pan.   |
| Wash Aluminum Pre-Filter.   |
| Wash ESP Unicell.   |
| <b>EVERY 2 - 4 WEEKS OR AS NEEDED</b> - Replace Charcoal Filter.  |

### 1-MONTH OWNERS FIRE SYSTEM INSPECTION AND MAINTENANCE

Monthly inspections shall be performed as per NFPA-17A and are required by Buckeye Fire Equipment.

On a monthly basis the owner of the Kitchen Mister Fire Suppression System must perform a "quick check" to verify the following:

|  |
|--|
| 1. The extinguishing system is in it's proper location   |
| 2. The manual actuators are unobstructed.  |
| 3. The tamper indicators and seals are intact.   |
| 4. The maintenance tag or certificate is up to date and in place.  |
| 5. No obvious physical damage or condition exists that may prevent operation.  |
| 6. The pressure gauge is in the operable range.  |
| 7. The nozzle blow off caps are intact and undamaged.  |
| 8. The inlet aperture and ventilation duct have not been replaced, modified, or relocated.                                       |
| <b>If any deficiencies that are found, the owner is to contact an Authorized Buckeye Fire Equipment Distributor immediately.</b> |

Note: A record of monthly inspections must be kept by the owner of the system that includes the date of inspection, the person performing the inspection, and any corrective action required.

## REQUIRED EVENT SYSTEM MAINTENANCE SCHEDULE

### 6-MONTH MAINTENANCE

Inspection and testing of the fire suppression system as per the Buckeye Model BFR-5 Kitchen Mister Automatic Fire Suppression System manual Chapter 5, Revision 5 "System Inspection and Maintenance".

### ANNUAL 12-MONTH MAINTENANCE

Inspection and testing of the fire suppression system as per the Buckeye Model BFR-5 Kitchen Mister Automatic Fire Suppression System manual Chapter 5, Revision 5 "System Inspection and Maintenance".

### 12-YEAR MAINTENANCE

Inspection and testing of the fire suppression system as per the Buckeye Model BFR-5 Kitchen Mister Automatic Fire Suppression System manual Chapter 5, Revision 5 "System Inspection and Maintenance".

## FILTER AND SURFACE CLEANING MAINTENANCE SCHEDULE

**Establish a regular filter and surface cleaning schedule to ensure the safety and proper operation of your Evo EVent® unit.**

Depending on the types of foods being cooked and the duration of cooking, you may need to adjust your cleaning schedule.

| Clean Each Day               | Wash End Of Day            | Wash Each Week Or As Necessary      | Every 2-4 Weeks Or As Necessary |
|------------------------------|----------------------------|-------------------------------------|---------------------------------|
| Cooking Surface              | Ventilation Inlet Aperture | Stainless Steel Grease Filter       | Replace Paper Charcoal Filter   |
| Granite Surfaces             | Ventilation Inlet Duct     | Grease Filter Enclosure             |                                 |
| Stainless Steel Top Surfaces | Crumb Drawer               | ESP Filter Unicells                 |                                 |
| Stainless Steel Side Panels  | Spill Over Pan and Drawer  | ESP Bottom Pan                      |                                 |
| Stainless Steel Toe Kicks    |                            | ESP Aluminum Pre-Filter             |                                 |
|                              |                            | Wipe Clean All Internal Ducts / ESP |                                 |

**Do not use stainless steel cleaners or degreasers on the electronic display panel. Clean with damp terry cloth towel using warm water only.**

**ONLY USE EVO BRANDED PAPER CHARCOAL FILTER PRODUCTS TESTED AND CERTIFIED FOR USE WITH THIS EQUIPMENT. THE USE OF OTHER CHARCOAL FILTER PRODUCTS WILL ADVERSELY AFFECT AIR QUALITY AND VOID THE MANUFACTURER'S WARRANTY.**

| Filter                            | Item Number | Type       |
|-----------------------------------|-------------|------------|
| Stainless Steel Grease Filter     | 13-0220-EVT | Washable   |
| ESP Aluminum Pre-Filter           | 13-0110-EVT | Washable   |
| ESP Filter Unicell                | 13-0200-EVT | Washable   |
| Evo Branded Paper Charcoal Filter | 13-0230-EVT | Disposable |

**Email [Sales@evoamerica.com](mailto:Sales@evoamerica.com) for Evo Genuine Parts and Accessories.**

**Phone: 866-626-1802**  
**Monday - Friday from 8am to 5pm PST**

**Website:**  
**<http://www.evoamerica.com>**

## CLEANING THE COOKING SURFACE

It's important to keep you cooking surface clean to prevent food from sticking, to provide better heat conductivity, to prevent unwanted flavors, and to provide a better overall appearance of your display cooking unit.

### PROCEDURE

|   |
|---|
| 1. Start by scraping large particles of debris with the Mini Grill Scraper. Scrape the debris into the spillover tray located at the lower left of the cooking surface. |
| 2. Place one gray polishing pad between the handle base and one grill screen, so the grill screen makes direct contact with the cooking surface.                        |
| 3. Pour a small amount of vegetable oil on the cook surface and lightly scrub the surface in a circular motion.   |
| 4. Wipe the surface clean with a paper towel or cotton terrycloth towel.  |
| 5. Finish by wiping a small amount of vegetable oil over the entire surface to condition the steel surface and help prevent rusting.                                    |

### TOOLS NEEDED TO PROPERLY CLEANING THE COOKING SURFACE

|                                   |
|-----------------------------------|
| Metal Scraper                     |
| Grill Screen Handle Grill Screen  |
| Grill Polishing Pad               |
| Vegetable Oil                     |
| Paper Towels or Terrycloth Towels |

### TIPS FOR SUCCESS

|  |
|--|
| 1) The cooktop is easier to clean when slightly warm.  |
| 2) Clean the cooktop after each use.   |
| 3) A scraper also works well for removing heavy food particles.  |
| 4) Small amount of water can be used to loosen food particles when the cooktop is slightly warmed. Never put water on a hot cooking surface, and never create steam that may enter the inlet aperture and damage the fusible fire system link. |

## Manual Actuation Of The Fire Pull Station

If there is a fire on the cooking surface or inside the unit, there is a Manual Fire Pull Station that when activated will dispense fire suppression chemical onto the cooking surface and into the internal ventilation duct.

To activate the Fire Pull Station, grab and pull the handle outward and away from the cooking unit chassis.



Fire Pull Station - Pull Handle

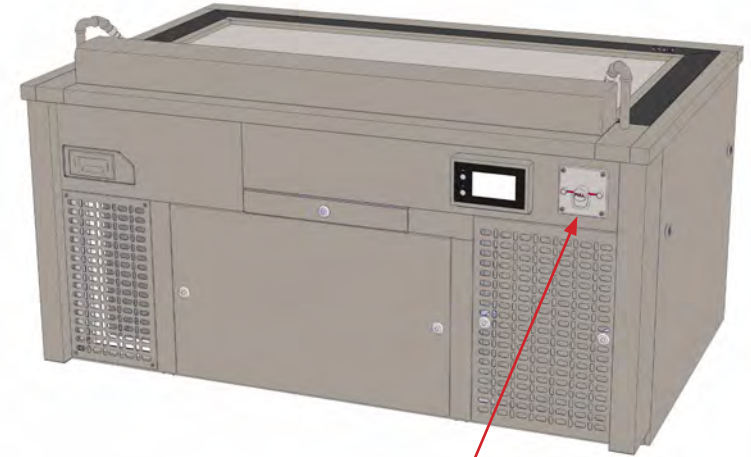

Manual Fire Pull Station  
Located on the front  
right-hand side.

**Note:** Use caution when cleaning the around the Pull Station to avoid accidental discharge of the Fire Suppression System.



**CAUTION:** Avoid the operation of this cooking appliance with loose clothing which may become tangled onto the Fire Pull Station and cause an accidental Fire System Discharge.

## FIRE SUPPRESSION SYSTEM

The Evo EVeNt® 48E is equipped with the latest in technology and safety and includes a Buckeye Model BFR-5, Kitchen Mister Automatic Fire Suppression System. The Model BFR-5 Fire Suppression System must be periodically inspected and maintained by an Authorized Factory Trained Buckeye distributor. Inspection and maintenance procedures must adhere to the design, installation, and maintenance manual part# BFR-TM, NFPA 17A, Sections of NFPA 96 where applicable, Local, State, and National Codes as well as the UL listing. See fire system maintenance schedule listed in Appendix 1.

### IN CASE OF FIRE

1. Evacuate all personnel and customers from the fire area.
2. Call the fire department.
3. If your EVeNt fire control system has not automatically activated, you may activate it manually by pulling the handle on the manual pull station.
4. When the fire has been extinguished, and the fire department has deemed it safe to re-enter and has determined the cause of the fire, call Evo at 503-626-1802 to dispatch a fire contractor to reset and recharge the system. Once the equipment has cooled and it is safe to touch, clean the discharge area using sponges with hot soapy water and detergents.

CAUTION: DO NOT USE ANY FLAMMABLE CLEANING SOLVENTS.

NOTE: It is critical to determine the cause of the fire and to correct the conditions which caused the fire prior to re-starting your operation. Under no circumstances should cooking operations be attempted before a factory trained and authorized Buckeye Fire Equipment distributor re-instate the integrity of your fire suppression system.

### MAINTENANCE

To ensure the best possible fire protection for the restaurant:

1. Arrange for proper inspection and maintenance of the fire control system as well as hand portables.
2. Eliminate all potentially combustible materials and arrange for their proper storage.
3. Arrange for upgrading of the fire suppression system if cooking equipment is added or revised and provide protection for changes made to the ventilation system.
4. Arrange for a continuing education program in the restaurant fire suppression system operation as new employees are added to the staff.
5. Assure that good housekeeping practices have been maintained to eliminate potential fire hazards.

## FIRE SUPPRESSION SYSTEM

### REGULARLY SCHEDULED INSPECTION

The Buckeye Fire Equipment Kitchen Mister Restaurant Cooking Area Fire Suppression System is a sophisticated fire suppression system, involving intricate mechanical components. To ensure the proper operation of the system, regular inspection and maintenance must be performed by an authorized trained Buckeye Fire Equipment distributor on a semi-annual basis, and after every periodic hood and duct cleaning (whichever occurs more frequently). This system is made up of individual components that are listed by Underwriters Laboratories Inc, with limitations contained in the detailed installation manual. The authorized distributor must be consulted after the system is discharged or whenever changes are planned for the system and/or area of protection.

**NFPA 17A and Buckeye Fire Equipment require that regularly scheduled (at a minimum of once a month) inspections of the system be conducted by the owner (or his representative). These monthly inspections are necessary to assure that the system is in proper working order and is ready when required.**

The following “quick review” of the Kitchen Mister System must include, but not limited to the following:

1. Determine that the cylinder, control head, gas valve, and all other components of the system are in place and has not been tampered with.
2. Determine that all appliances are still in their original position, as when the system was installed.
3. Check that the manual pull station is unobstructed and in clear view with all labeling and instructions visible.
4. Visually inspect the pressure gauge on the cylinder valve assembly to make sure the system pressure is within proper range. The yellow pointer should be in the middle of the green operable range.
5. Visually inspect the system detection lines to make sure that the cable and fusible links are not damaged, obstructed or have been moved.
6. Inspect all nozzles, making sure they are clean and free from any grease or carbon build-up. Assure that all blow-off covers are in place.
7. Check that all inspection tags or certificates are in place and up to date. A record of monthly inspections shall be maintained showing the date of the inspection, who conducted the inspection and what actions were taken if required.
8. If any deficiencies are found, call your authorized trained Buckeye Fire Equipment distributor so that the appropriate corrective action can be taken.

**NOTE:** The best method of fire prevention is good “housekeeping practices” which eliminate potential fire hazards. Inspect the overall cleanness and operation of the appliance, plenum and filters. If any problems or deficiencies are found, appropriate corrective action must be taken immediately, by notifying the appropriate parties.

Call your local fire suppression company to confirm or schedule your semi-annual inspection and maintenance visit. At this time, it is also good practice to visually inspect all hand portable fire extinguishers to verify that each is in good working condition. Refer to extinguisher’s manual for detailed instructions.

## RESTARTING AFTER A FIRE SYSTEM DISCHARGE

The fire suppression system in the Event® unit uses a Potassium Carbonate (Potash) liquid solution that is dispensed under pressure from 2 nozzles on each right and left side of the Inlet Aperture and 1 nozzle located inside the grease filter box. A Fire System Discharge can occur because there is a fire within the cooking surface area with the ventilation fan operating, or there is a fire system discharge the ventilation fan Off and not operating.

### THE FOLLOWING EXPLAINS CAUSES ASSOCIATED WITH A FIRE SYSTEM DISCHARGE:

#### WHEN THE VENTILATION FAN IS OPERATING

- 1) There is a fire within the cooking surface area causing flame to enter the inlet aperture and release the fusible link.
- 2) There is excessive steam generated on the cooking surface which enters the inlet aperture and releases the fusible link.
- 3) The Fire Pull Station has been triggered discharging the fire system.

#### WHEN THE VENTILATION FAN IS OFF

- 1) The inlet aperture is being cleaned using hot water or steam causing a release of the fusible link.
- 2) The inlet aperture is being cleaned using corrosive cleaners (oven cleaner) which has damaged the fusible link causing a release of the fusible link.
- 3) The inlet aperture fusible link is disturbed during cleaning causing a release of the fusible link.
- 4) The Fire Pull Station has been triggered discharging the fire system.

### RESTARTING AFTER A FIRE SYSTEM DISCHARGE:

- 1) **IF THERE IS A FIRE EMERGENCY, IMMEDIATELY CALL THE LOCAL FIRE DEPARTMENT TO REPORT THE ISSUE.**
- 2) Call the Fire Contractor associated with servicing your Event unit to report the incident and request a service call. The Fire Contractor telephone number is found on the service tag affixed to the fire pull station.
- 3) Report the issue to Evo America, LLC by calling Evo Support at 503-626-1802 or Toll-Free at 866-626-1802.

### CLEANING THE EVENT UNIT AFTER A FIRE SYSTEM DISCHARGE:

#### IF THE VENTILATION FAN WAS OPERATING

- 1) Request an Authorized Buckeye Fire Contractor service the Event unit to recharge the fire suppression system
- 2) Inspect the internal duct system for fire damage or melting of internal duct components. If fire melt damage is found call Evo, Inc at 503-626-1802. If no internal duct damage is found, remove and wash the inlet aperture, remove all filters and support brackets and wash all parts thoroughly to remove all traces of fire suppression chemical. Using soap and water, thoroughly wash and wipe all traces of fire suppression chemical from the inside of the duct and ESP enclosure and ESP door components.
- 3) Replace the charcoal filter with a new charcoal filter.

#### IF THE VENTILATION FAN WAS NOT OPERATING

- 1) Request an Authorized Buckeye Fire Contractor service the Event® unit to recharge the fire suppression system
- 2) Remove and wash the inlet aperture, remove all filters and support brackets and wash all parts thoroughly to remove all traces of fire suppression chemical. Using soap and water, thoroughly wash and wipe all traces of fire suppression chemical from the inside of the duct and ESP enclosure and ESP door components.
- 3) Replace the charcoal filter with a new charcoal filter.



## FIRE SYSTEM ALARM MICRO SWITCH

An Alarm Micro Switch is available inside the Buckeye Switch Release Mechanism (SRM) control box that allows the connection for an alarm initiating circuit as per NFPA 72 "Nation Fire Alarm Code". This switch is pre-installed at the Evo factory by an Authorized Buckeye Distributor and is location on the front of the Manifold Block.

The following diagram is supplied for reference purposes only. Refer to installation instructions supplied with the Buckeye Kitchen Mister Technical Manual BFR-TM, Edition January 1, 2013, Appendix B - Accessories, Page B-1, Revision 5.

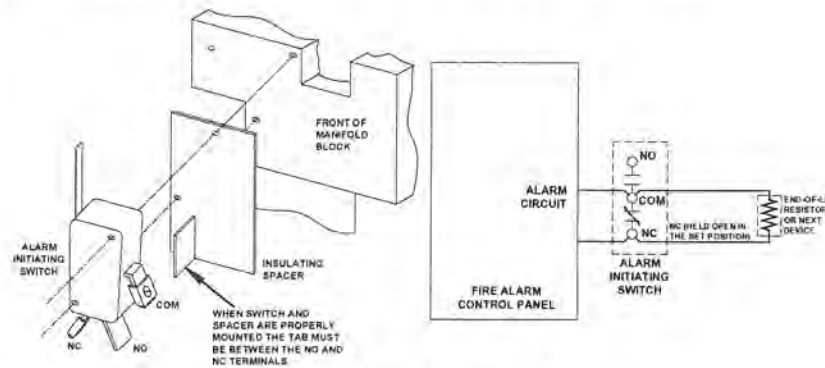

| <b>Specifications</b>                             | <b>4 Heating Elements (up to 2 heaters energized at any given time)</b> |
|---|---|
| Cooking Surface Dimensions (overall griddle size) | 48" x 24" (1219mm x 610mm)  |
| Cooking Zone Dimensions (direct heat area)        | 23.25" x 16.25" (591mm x 413mm)   |
| Heating Element Power (KW/BTU)                    | 6KW / 20,473 BTU (2 heaters)  |
| Heating Element Voltage (V)                       | 208V - 220V   |
| Phase   | 1   |
| Frequency (Hz)                                    | 60 HZ   |
| Current (A)                                       | 32 A (2 heaters maximum plus ventilation fan in full operation)         |
| Maximum Current Requirement (A)                   | 40 A Breaker  |
| Plug Wire   | 2 Pole, 1 Wire Ground   |
| Plug  | NEMA 6-50P, 2 Pole, 3 Wire, Straight Blade                              |





**Evo America, LLC**

20360 SW Avery Ct., Tualatin, OR 97062

Ph 866.626.1802 Fax 503.213.5869 sales@evoamerica.com

Evo is protected under U.S. Patents 9,897,328, 9,869,474, 10,139,113, 9,903,595, 10,842,540, 7,825,353 and U.S. Patents Pending. Evo is a registered trademark of Evo America, LLC. ©2021 All rights reserved.